



INSTRUCTION MANUAL

IP REMOTE CONTROL SOFTWARE

RS-BA1

Version 2

INTRODUCTION

1 BEFORE USING THE REMOTE CONTROL SYSTEM

2 CONFIGURING THE SYSTEM THROUGH A CABLE

3 CONFIGURING THE SYSTEM THROUGH A LAN

4 CONFIGURING THE SYSTEM THROUGH THE INTERNET

5 ABOUT THE REMOTE UTILITY

6 ABOUT THE REMOTE CONTROLLER

7 TROUBLESHOOTING

INTRODUCTION

Thank you for choosing this Icom product. This product is designed and built with Icom's state of the art technology and craftsmanship. With proper care, this product should provide you with years of trouble-free operation.

This instruction manual contains detailed instructions on how to configure your own remote control system. Before reading this manual, read the RS-BA1 Preparations that comes with the RS-BA1 for details on how to install the software.

IMPORTANT

READ THIS INSTRUCTION MANUAL CAREFULLY before using the software.

SAVE THIS INSTRUCTION MANUAL. This instruction manual contains important safety and operating instructions for the RS-BA1.

NOTE: This instruction manual is based on Icom Remote Utility Version 2.10 and RS-BA1 Version 2.00.

- In this manual, Microsoft® Windows® 10 Home and Microsoft® Windows® 10 Pro are described as "Windows 10."
- Microsoft® Windows® 8.1 and Microsoft® Windows® 8.1 Pro are described as "Windows 8.1." The software cannot be used with "RT" versions of Microsoft® Windows® 8.1.
- Microsoft® Windows® 7 Home Premium, Microsoft® Windows® 7 Professional, and Microsoft® Windows® 7 Ultimate are described as "Windows 7."

Icom is not responsible for the destruction, damage to, or performance of any Icom or non-Icom equipment, if the malfunction is because of:

- Force majeure, including, but not limited to, fires, earthquakes, storms, floods, lightning, other natural disasters, disturbances, riots, war, or radioactive contamination.
- The use of Icom transceivers with any equipment that is not manufactured or approved by Icom.

PRECAUTIONS

IMPORTANT! To remotely control radios using the RS-BA1, **BE SURE** that you comply with any local regulations.

The RS-BA1 is designed to remotely control transceivers through a LAN or USB port (Type B/Mini-B).

Proper audio communication cannot be guaranteed if you connect the Server PC to the transceiver's ACC socket, MIC connector, or S/PDIF jack.

Depending on your transceiver, a few functions or modes cannot be used, or you will need to update the transceiver's firmware to operate a CW keyer, using the RS-BA1 application.

Depending on the PC's performance, OS, IP provider, connection type, condition, speed, and so on, the USB audio may be interrupted, or control by the PC software may get delayed.

If the CPU has a heavy load, the USB audio is easily interrupted. The settings of your audio player application may be changed after connecting a transceiver to the PC.

To operate your PC and peripheral devices, follow the instructions provided in their manuals.

All copyrights associated with this manual and all intellectual property rights associated with the RS-BA1 application are held by Icom Inc. Unauthorized reproduction or transmission of this manual, or any part hereof, is prohibited.

The content of this manual, the software associated with the RS-BA1, and the appearance of the RS-BA1 are all subject to change without notice.

Icom, Icom Inc. and the Icom logo are registered trademarks of Icom Incorporated (Japan) in Japan, the United States, the United Kingdom, Germany, France, Spain, Russia, Australia, New Zealand, and/or other countries.

Adobe, Acrobat, and Reader are either registered trademarks or trademarks of Adobe Systems Incorporated in the United States and/or other countries.

Microsoft and Windows are registered trademarks of Microsoft Corporation in the United States, and/or other countries.

All other products or brands are registered trademarks or trademarks of their respective holders.

FUNCTIONS AND FEATURES OF Adobe® Acrobat® Reader®

The following functions and features can be used with Adobe® Acrobat® Reader®.

• **Keyword search**

Click “Find” (Ctrl+F) or “Advanced Search” (Shift+Ctrl+F) in the Edit menu to open the search screen.

This is convenient when searching for a particular word or phrase in this manual.

① The menu screen may differ, depending on the Adobe® Acrobat® Reader® version.

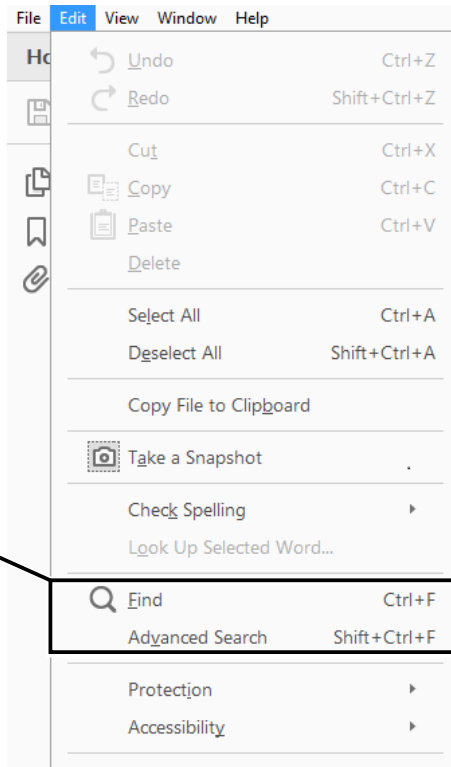

Click to open the find or search screen or advanced search screen.

• **Find screen**

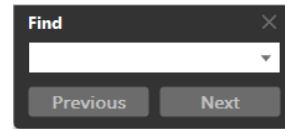

• **Advanced search screen**

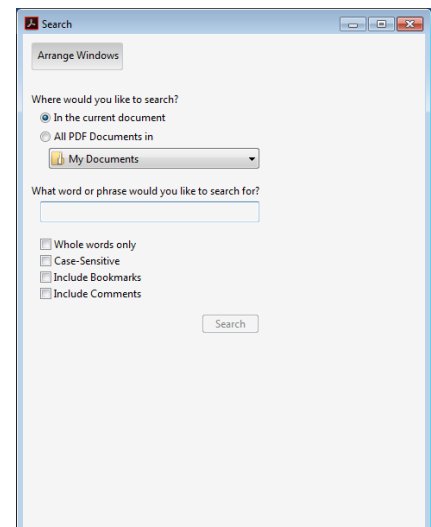

• **Printing out your desired pages.**

Click “Print” in the File menu, and then select the paper size and page numbers you want to print.

① The printing setup may differ, depending on the printer. Refer to your printer’s instruction manual for details.

① Select “A4” size to print out the page in the original manual size.

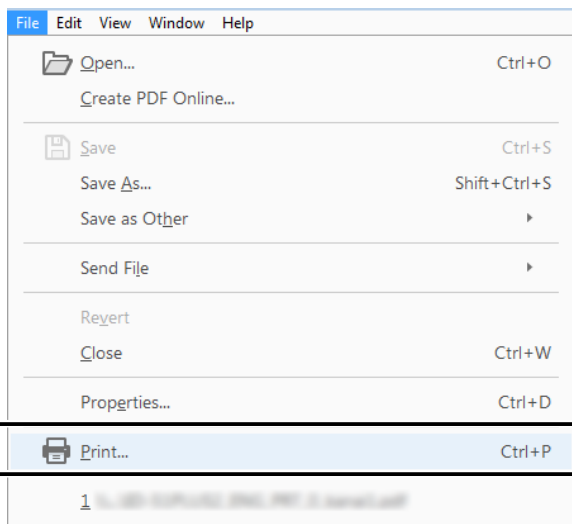

• **Read Out Loud feature.**

The Read Out Loud feature reads aloud the text in this PDF.

Refer to the Adobe® Acrobat® Reader® Help for the details.

(This feature may not be usable, depending on your PC environment including the operating system.)

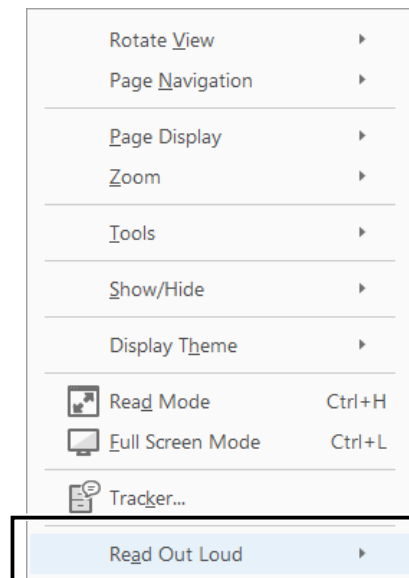

① The screen may differ, depending on the Adobe® Acrobat® Reader® version.

INTRODUCTION

COMPATIBLE TRANSCEIVERS

The RS-BA1 is compatible with Icom transceivers that input and output audio through a LAN or the USB port (Type B/Mini-B).

Transceiver's connector	Compatible transceivers
LAN port (Transceivers with the Server function)	IC-7851, IC-7850, IC-7800 (Firmware version 3.00 or later), IC-7700 (Firmware version 2.00 or later), IC-7610
USB port	IC-7100, IC-7200, IC-7300, IC-7410, IC-7600, IC-7610, IC-7850, IC-7851, IC-9100

NOTE:

- If your Icom transceiver does not have a LAN port or a USB port, you can remotely control the transceiver with an RS-232C interface. However, RS-BA1 operation with transceivers that input or output audio through the ACC socket, MIC connector, or S/P DIF jack cannot be guaranteed.
- Depending on your transceiver, some functions or operating modes cannot be used.
- Depending on your transceiver, a firmware update may be required to use the CW mode.

The following transceivers are compatible with the RS-BA1 Dualwatch function:

IC-7851, IC-7850 (Firmware version 1.30 or later)

IC-7610 (Firmware version 1.10 or later)

TABLE OF CONTENTS

1	BEFORE USING THE REMOTE CONTROL SYSTEM	1-1
■	Firewall settings.....	1-1
■	Adjusting the level of your audio devices	1-5
■	Transceiver's presetsings	1-8
■	Selecting a connection method	1-10
2	CONFIGURING THE SYSTEM THROUGH A CABLE	2-1
■	Examples of the remote control system	2-1
■	STEP 1. Select a connection method.....	2-2
■	STEP 2. Connecting the transceiver to the PC	2-3
■	STEP 3. Setting the Remote Utility	2-7
■	STEP 4. Starting the Remote control operation	2-11
3	CONFIGURING THE SYSTEM THROUGH A LAN	3-1
■	Examples of the remote control system	3-1
■	STEP 1. Settings on the Base station	3-2
◇	A. When using a transceiver with the Server function.....	3-2
◇	B. When using the Server PC	3-4
■	STEP 2. Settings on the Remote PC's Remote Utility application	3-10
■	STEP 3. Starting the Remote control operation	3-14
4	CONFIGURING THE SYSTEM THROUGH THE INTERNET	4-1
■	Examples of the remote control system through the Internet.....	4-1
■	About a public IP address and the Dynamic DNS service	4-2
◇	To let PCs connect to the Base station using its public IP address.....	4-2
◇	To let PCs connect to the Base station using its domain name	4-3
■	Port forwarding	4-4
■	STEP 1. Settings on the Base station	4-5
◇	A. When using a transceiver with the Server function.....	4-5
◇	B. When using the Server PC	4-7
■	STEP 2. Settings on the Remote PC's Remote Utility application	4-11
■	STEP 3. Starting the Remote control operation	4-15

TABLE OF CONTENTS

- 5 ABOUT THE REMOTE UTILITY 5-1**
 - Setting your PC's environment..... 5-1
 - Transceiver Registration 5-2
 - ◇ Adding a transceiver 5-2
 - ◇ Changing a transceiver's properties..... 5-3
 - ◇ Deleting a transceiver 5-3
 - ◇ Adding a user who can access the transceiver..... 5-4
 - Server Registration..... 5-7
 - ◇ Adding a Server 5-7
 - ◇ Changing a server's properties 5-8
 - ◇ Deleting a server 5-8
 - Connecting to a Server..... 5-9
 - ◇ Connecting to a Server 5-9
 - ◇ Disconnecting from a Server..... 5-9
 - Connection setting..... 5-10
 - Connecting to a transceiver..... 5-11
 - ◇ Connecting to a transceiver 5-11
 - ◇ Disconnecting a transceiver..... 5-11
 - Adjusting audio level using the Remote Utility application 5-12
 - ◇ Adjusting received audio volume 5-12
 - ◇ Adjusting transmit audio volume 5-12
 - Recording and playback function 5-13
 - ◇ Recording received audio 5-13
 - ◇ Playing back and transmitting an audio file..... 5-14
 - Monitoring another users from the Server PC..... 5-15
 - Disconnecting another users..... 5-16

- 6 ABOUT THE REMOTE CONTROLLER 6-1**
 - To use transmit audio input from the PC 6-2
 - About the Remote mode 6-2
 - Using the RC-28..... 6-3

- 7 TROUBLESHOOTING..... 7-1**

OVERVIEW OF THE RS-BA1

- The RS-BA1 consists of the Remote Utility, used to configure a remote control system, and the Remote Controller, used to send the CI-V commands to a Base station, to remotely operate it.
- With the RS-BA1, you can configure a remote control system through a LAN or the Internet.

About the Remote Control system

The RS-BA1 Remote Control system basically consists of the following 3 components:

- ① Base station: Transceiver, or Transceiver and Server PC*
- ② Network (LAN or Internet)
- ③ Remote station: PC (Remote PC)

* If you use a transceiver that does not have the Server function, you have to connect a PC to the transceiver.

In the Remote Control system, you can transmit or receive the CI-V commands, control commands to turn the transceiver ON or OFF, or communication audio through the Remote Utility. You can remotely control the base station by the Remote PC using the Remote Controller.

A. When using the transceiver with the Server function

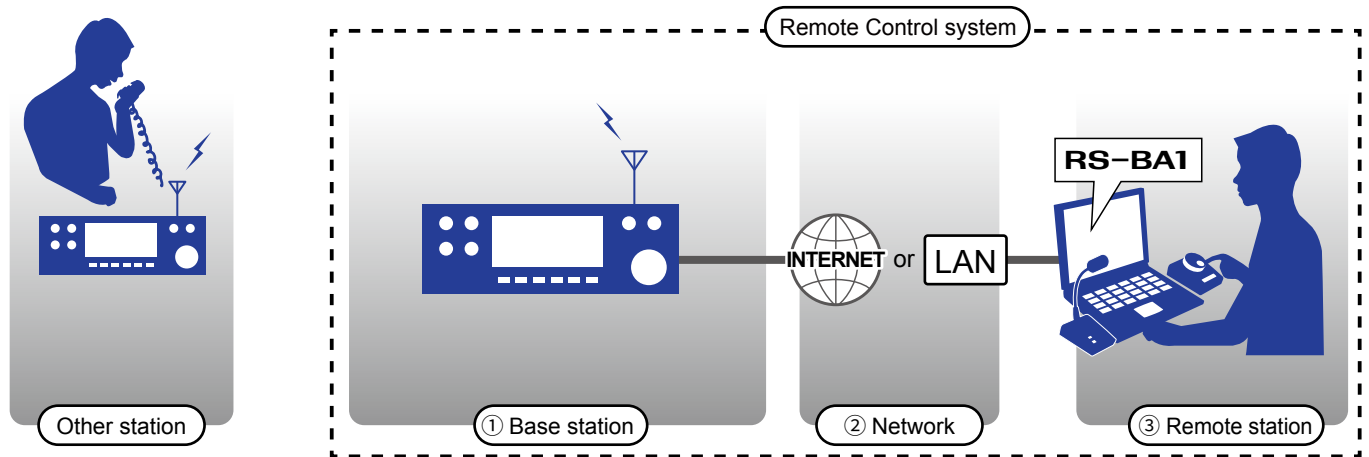

B. When using the transceiver and Server PC

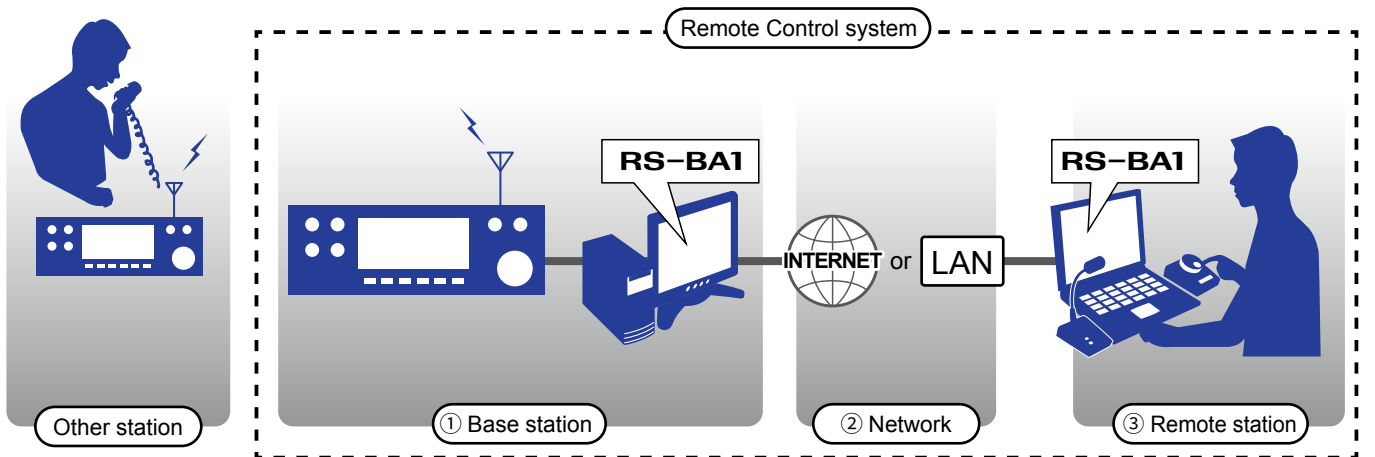

Firewall settings

The Windows operating system includes a firewall setting standard. This is a security function that can prevent improper access to your PC from the Internet. To let the Remote Utility work properly, add it as an exception in the firewall.

Windows 10

1. Click the Windows icon, and then click the Setting icon.

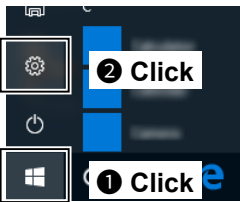

2. Click "Network & Internet."

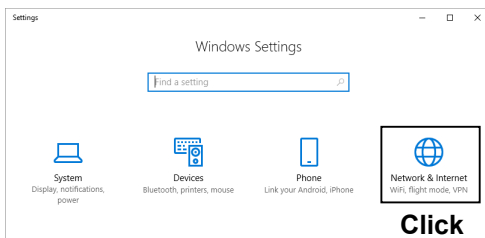

3. Click "Windows Firewall."

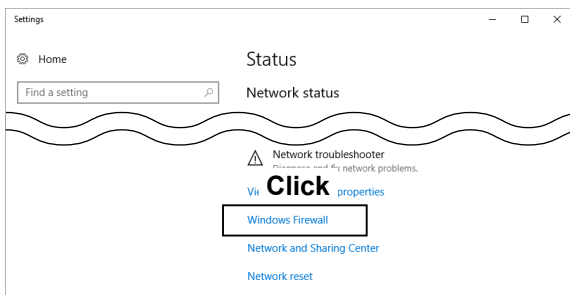

4. Click "Allow an app through the firewall."

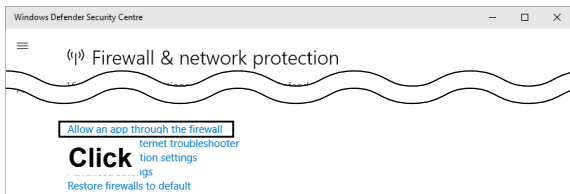

• The "Allowed applications" screen is displayed.

5. Click <Change settings>.

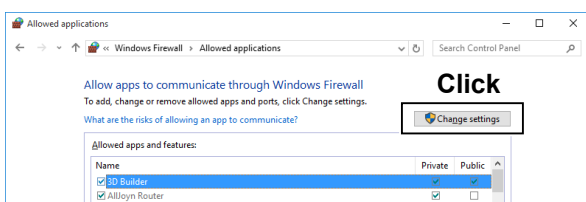

6. Click <Allow another app...>.

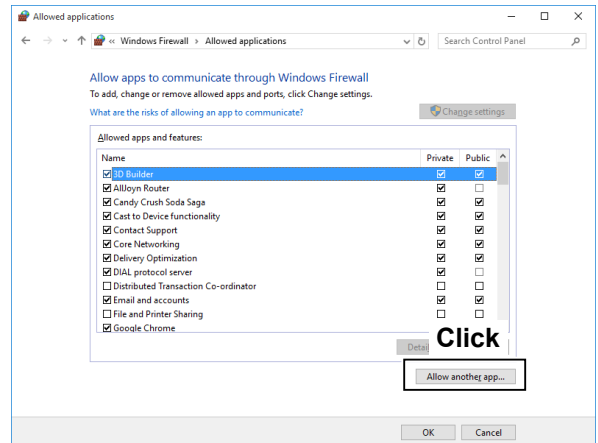

• The "Add an app" screen is displayed.

7. Click "Remote Utility Software for Icom Radios" and then click <Add>.

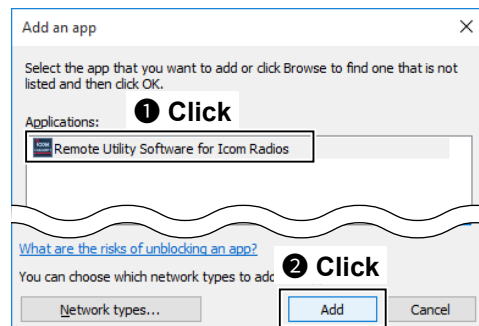

• Returns to the "Allowed applications" screen.

8. In the "Allowed apps and features" list, confirm that "Remote Utility Software for Icom Radios" is displayed and a check mark is in the box, and then click <OK>.

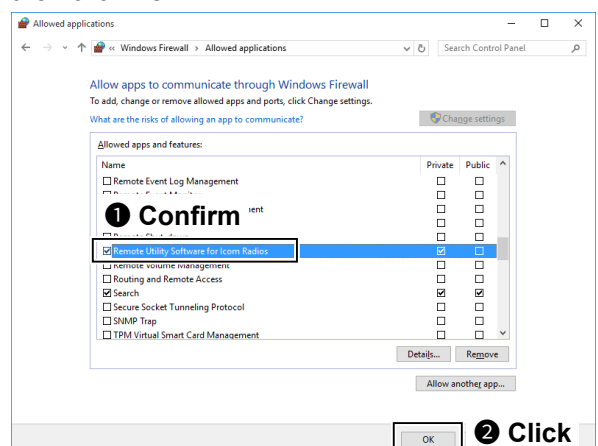

1 BEFORE USING THE REMOTE CONTROL SYSTEM

Firewall settings

Windows 8.1

1. Place the mouse pointer in the bottom right corner of the screen.
 - The charms are displayed on the right of the screen.

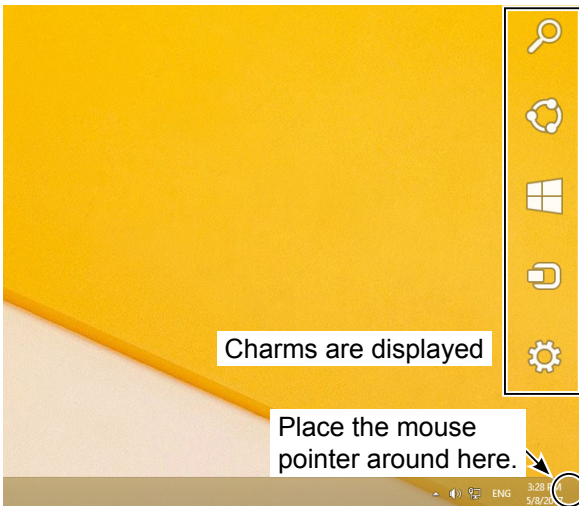

2. Click the "Settings" charm.

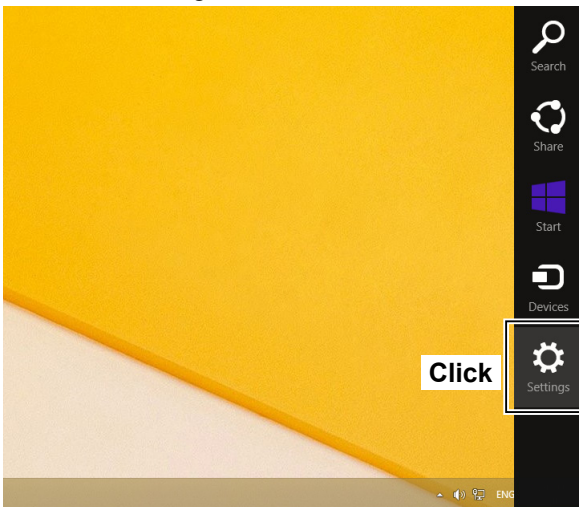

3. Click "Control Panel."

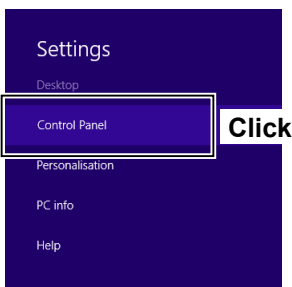

4. Click "System and Security."

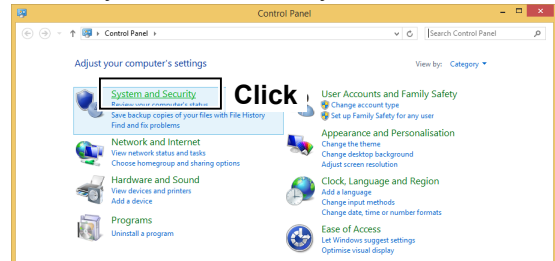

5. Click "Allow an app through Windows Firewall."

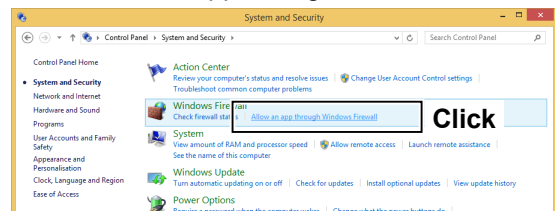

- The "Allowed applications" screen is displayed.

6. Click <Change settings>.

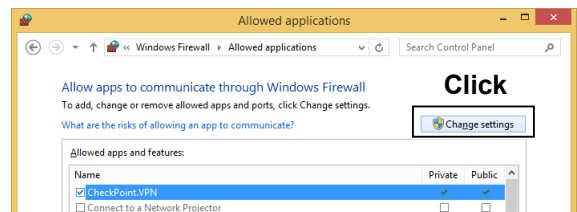

7. Click <Allow another app...>.

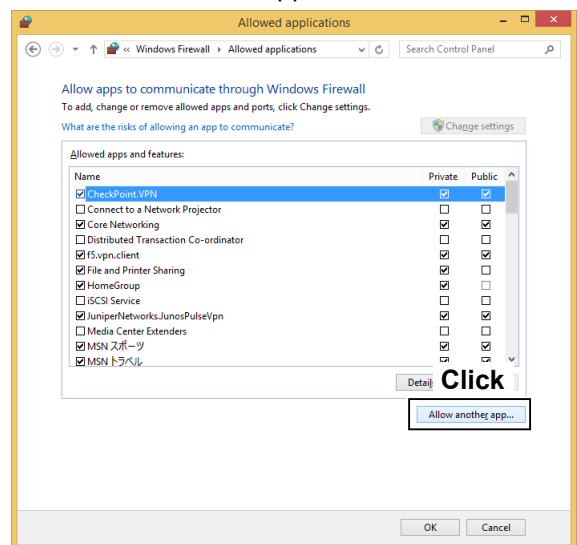

- The "Add an app" screen is displayed.

► Continued on the next page.

1 BEFORE USING THE REMOTE CONTROL SYSTEM

Firewall settings

Windows 8.1 (Continued)

8. Click “Remote Utility Software for Icom Radios” and then click <Add>.

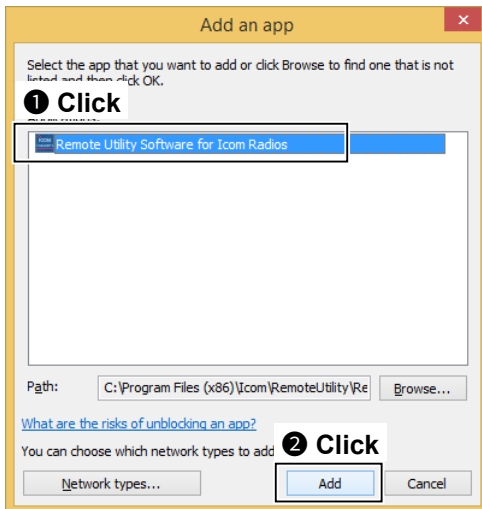

- Returns to the “Allowed applications” screen.
9. In the “Allowed apps and features” list, confirm that “Remote Utility Software for Icom Radios” is displayed and a check mark is in the box, and then click <OK>.

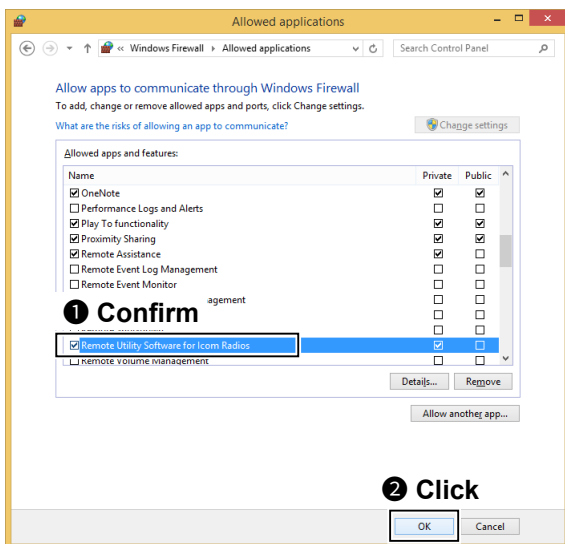

1 BEFORE USING THE REMOTE CONTROL SYSTEM

Firewall settings

Windows 7

1. Click "Control Panel" in the Start menu.
2. Click "System and Security."

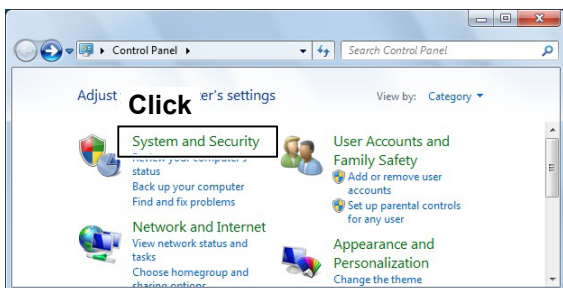

3. Click "Allow a program through Windows Firewall."

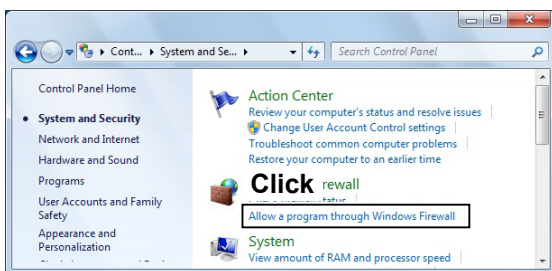

• The "Allowed Programs" screen is displayed.

4. Click <Change settings>.

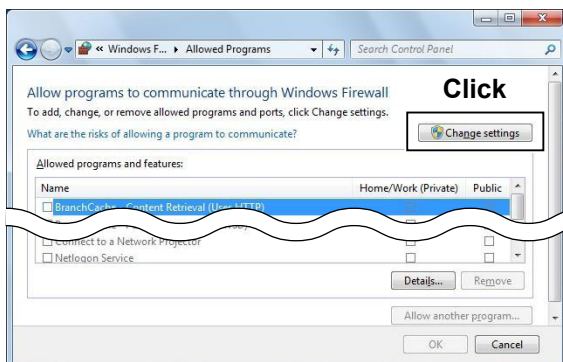

5. Click <Allow another program...>.

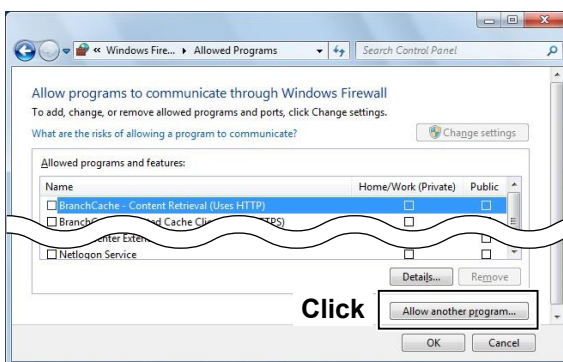

• The "Add a Program" screen is displayed.

6. Click "Icom Remote Utility" and then click <Add>.

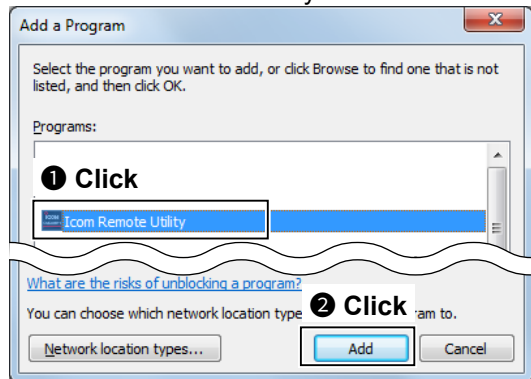

7. In the "Allowed programs and features" list, confirm that "Icom Remote Utility" is displayed and a check mark is in the box, and then click <OK>.

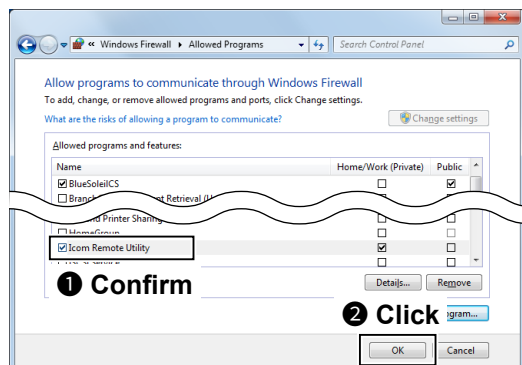

1 BEFORE USING THE REMOTE CONTROL SYSTEM

Adjusting the level of your audio devices

Before you start using the RS-BA1, the PC's audio volume of your speakers or headsets must be set to a proper level.

① Information

- When several audio devices are used, you must individually set each one.
- Configurable items, displayed screens, and terms may differ, depending on your PC.
- These instructions are based on using Windows 10.

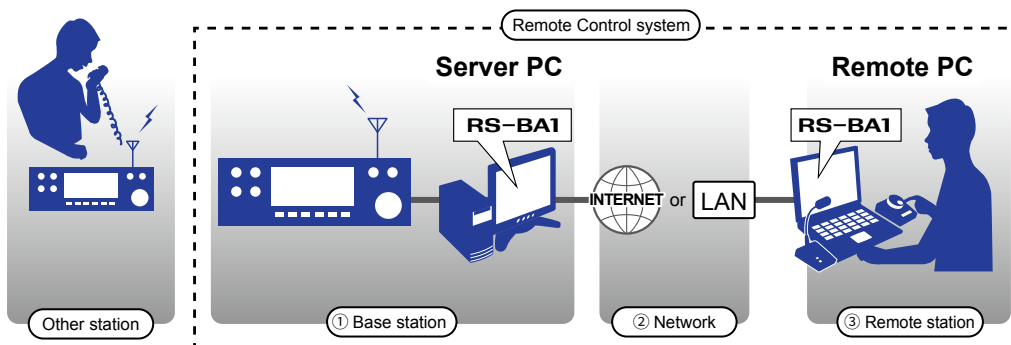

Settings for the Remote PC

Adjust the volume level of the audio device that is connected to the PC.

- In the “Playback devices” menu, you can adjust the output level of the speaker or headset.
- In the “Recording devices” menu, you can adjust the modulation level sent to the transceiver.

Settings for the Server PC

Adjust the audio input and output level from or to your transceiver.

- In the “Playback devices” menu, you can adjust the modulation level sent to the transceiver.
 - In the “Recording devices” menu, you can adjust the audio input level from the transceiver.
- ① Before adjusting, connect the transceiver and your PC, and turn ON the transceiver. (p. 2-2)

1. Right-click the speaker icon on the taskbar, then click “Playback devices” or “Recording devices.”

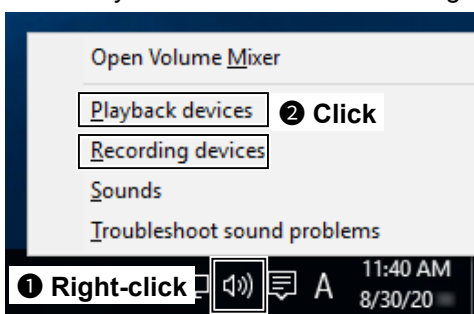

- The “Sound” screen is displayed.

2. Select the audio device that you use, then click <Properties>.

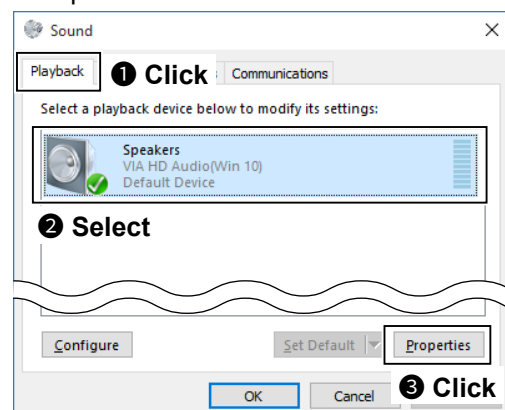

- The “Speaker Properties” screen is displayed.

► Continued on the next page.

1 BEFORE USING THE REMOTE CONTROL SYSTEM

Adjusting the level of your audio devices

3. Confirm “Use this device (enable)” is displayed in the Device Usage menu on the <General> tab.

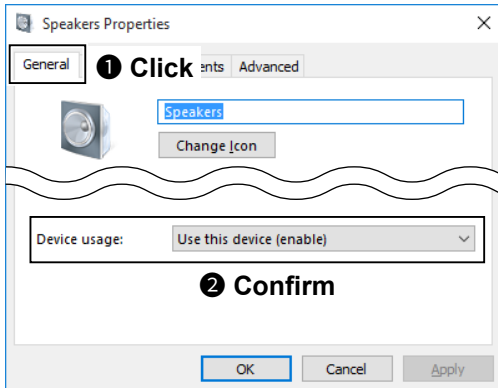

4. Click the <Levels> tab.
Adjust the speaker's audio level by moving the slide control to the right or left.
After adjusting, click <OK> to close “Speaker Properties.”

① If the mute setting is turned ON in “Speakers” (🔇), click the icon to turn it OFF.

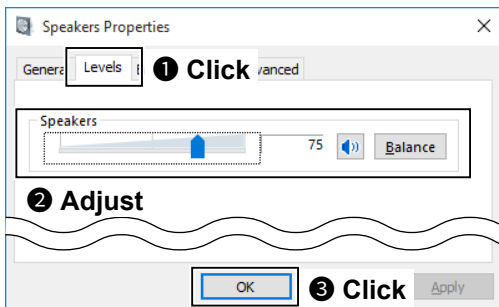

5. Click the <Recording> tab on the “Sound” screen.
In the list, select the audio device that you use, and then click <Properties>.

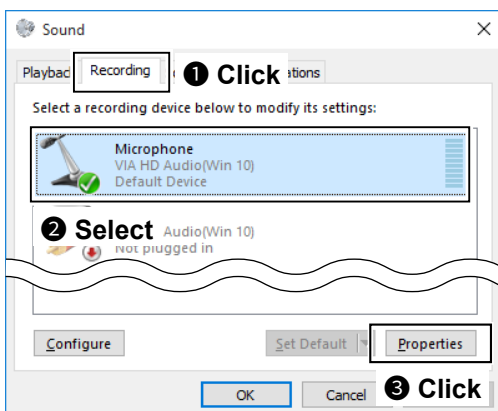

• The “Microphone Properties” screen is displayed.

6. Confirm “Use this device (enable)” is displayed in the Device Usage menu on the <General> tab.

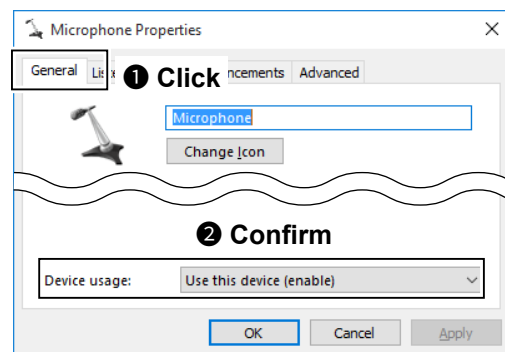

7. Click the <Listen> tab.
If a check mark is inserted in “Listen to this device,” click to remove it.

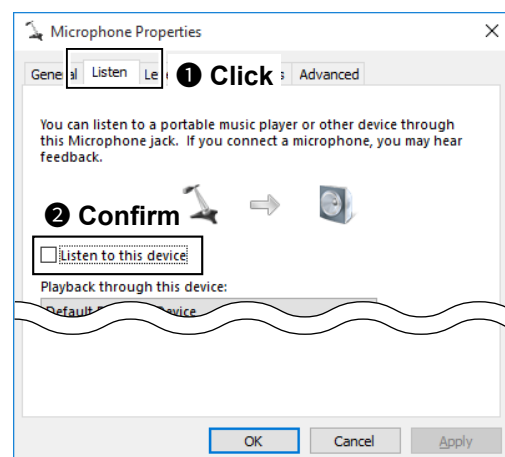

8. Click the <Levels> tab.
Adjust the microphone's audio level by moving the slide control to the right or left.

① If the mute setting is turned ON in “Microphone” (🔇), click the icon to turn OFF.

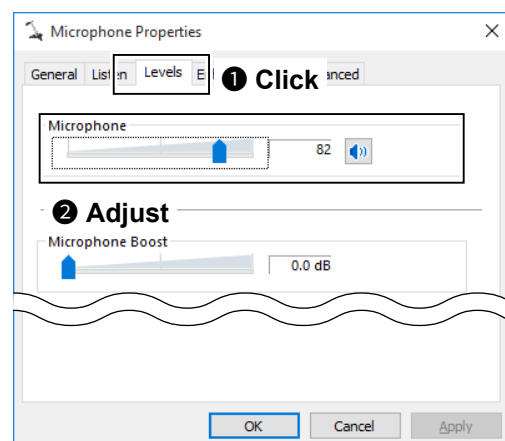

► Continued on the next page.

1 BEFORE USING THE REMOTE CONTROL SYSTEM

Adjusting the level of your audio devices

9. When connecting the transceiver to the PC with a the USB cable, and when using the RS-BA1 Dualwatch function, click the <Advanced> tab and then confirm the “Default Format” is set to 2 channel.

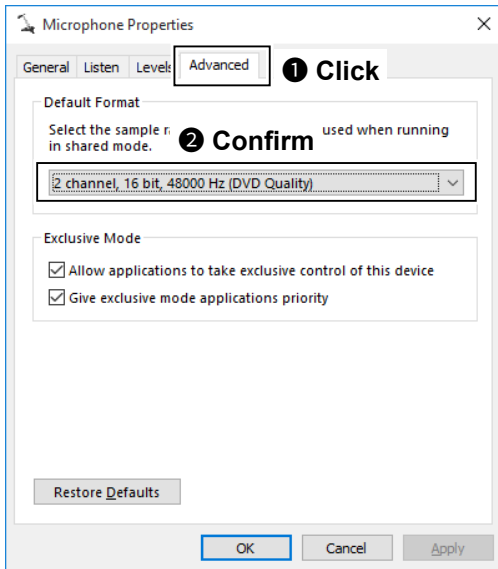

10. After adjusting, click <OK> to close “Microphone Properties.”

1 BEFORE USING THE REMOTE CONTROL SYSTEM

Transceiver's presets

The RS-BA1 remotely controls the transceivers using CI-V (Icom Communication Interface-V) commands. See the CI-V command table in the transceiver's instruction manual for details of the functions that can be controlled.

The following manual settings are required when operating the RS-BA1

Properly preset the items in the table below for functions that cannot be controlled by CI-V commands, or for items that may cause unintended actions. See the transceiver's instruction manual for details of the settings or operation.

NOTE:

- Remove the transverter from the transceiver, if it is connected.
- To prevent an accidental transmission, we recommend you remove any key, keypad, or other external devices connected to the transceiver.
- Set the transceiver to a normal operating mode. The transceiver cannot receive CI-V commands in special modes, such as the firmware update mode or cloning mode.
- If the transceiver has the Time-Out Timer function, we recommend that you turn ON the function to prevent the transceiver from continuously transmitting.

Genre	Items	Model	Contents
Function	RIT function	Transceivers without the Server function (Except for the IC-7100, IC-7300, IC-7600)	Set to OFF.
	▲TX function	Transceivers without the Server function (Except for the IC-7300, IC-7600)	Set to OFF.
	Simple band scope	IC-746PRO*1, IC-7000*1, IC-7100, IC-7400*1, IC-7410, IC-9100,	Set to OFF.
	SWR Measuring function	IC-746PRO*1, IC-7000*1, IC-7100, IC-7400*1, IC-7410, IC-9100	Set to OFF.
	Weather Alert function	IC-7100	Set to OFF.
	Timer/Sleep Timer function	Transceivers with the Timer function	Set to OFF.
Display	RTTY decode screen	IC-746PRO*1, IC-756PROIII*1, IC-7400*1	Close the screen.
Volume	Volume for the RX audio	All	Set to a suitable level.
CI-V	CI-V Baud Rate	All	19200 bps (or "Auto").
	CI-V Address	All	Desired CI-V Address ① If other devices are connected to the system, BE SURE to not set a duplicate address.
	CI-V USB Port	IC-7300*2, IC-7610*2, IC-7850 (Firmware version 1.10 or later)*2, IC-7851 (Firmware version 1.10 or later)*2	Set to "Unlink from [REMOTE]."
	CI-V USB Baud Rate	IC-7300*2, IC-7610*2, IC-7850 (Firmware version 1.10 or later)*2, IC-7851 (Firmware version 1.10 or later)*2	Set to "115200" (or "Auto").
Set mode	USB Serial Function	Transceivers with a USB (Type B) port	Set to "CI-V" for the selected connection method.
	RS-232C Function	Transceivers with an RS-232C port	Set to "CI-V" for the selected connection method.

*1 Operations cannot be guaranteed.

*2 When connecting to the USB port and using the Scope function.

NOTE: When using the IC-PW1, BE SURE to set CI-V Baud Rate to "19200 bps." After changing the transceiver's CI-V settings, be sure to reset the CPU of the IC-PW1 and set the transceiver's CI-V settings on the IC-PW1. See the IC-PW1 instruction manual for details.

1 BEFORE USING THE REMOTE CONTROL SYSTEM

Transceiver's presets

The following settings are automatically set in the transceiver

When the Remote Controller connects to the transceiver, and you select the model name on the Connect Setting screen, the following items are automatically set. If you manually operate the transceiver, set these items.

Genre	Items	Model	Contents
Function	MAIN/SUB Tranking function	IC-7610, IC-7850 (Firmware version 1.10 or later), IC-7851 (Firmware version 1.10 or later)	Automatically set to OFF.
	SSB/CW Synchronous Tuning	All	Automatically set to OFF.
	Calibration Marker	Transceivers with the Calibration Marker function	Automatically set to OFF.
	VOX function	All	Automatically set to OFF.
	Scan function	All	Automatically cancels the scan.
	RTTY filter	IC-746PRO* ¹ , IC-756PROIII* ¹ , IC-7400* ¹	Automatically set to OFF.
	Twin Peak Filter	IC-746PRO* ¹ , IC-756PROIII* ¹ , IC-7400* ¹	Automatically set to OFF.
Display	Dualwatch function* ²	IC-7600, IC-7800, IC-756PROIII* ¹	Automatically set to OFF.
	SUB band	IC-9100	Automatically set to OFF.
	Memory channel/ Call channel	All	Automatically set to the VFO mode.
Operating mode	DR (D-STAR Repeater) mode	IC-7100, IC-9100	Automatically set to OFF.
	Satellite mode	IC-9100	Automatically set to OFF.
CI-V	CI-V transceive	All	Automatically set to ON.
	CI-V 731 Mode	IC-746PRO* ¹ , IC-756PROIII* ¹ , IC-7400* ¹	Automatically set to OFF.

*¹ Operations cannot be guaranteed.

*² The Dualwatch function is automatically set to OFF when using the Single mode screen

1 BEFORE USING THE REMOTE CONTROL SYSTEM

Selecting a connection method

There are 3 connection methods. Select one from the following.

When you want to configure the system using a cable, see Section 2.

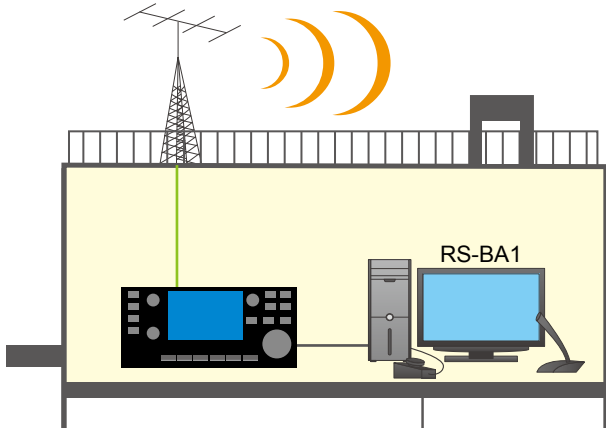

When you want to configure the system using a LAN, see Section 3.

① When using a transceiver with the Server function, you do not need a Sever PC.

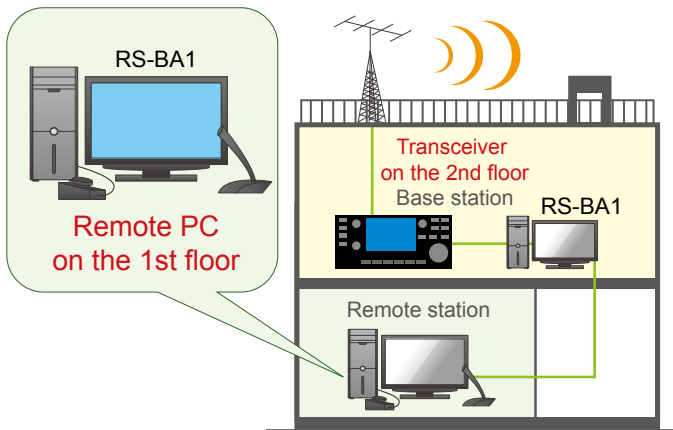

When you want to configure the system using the Internet, see Section 4.

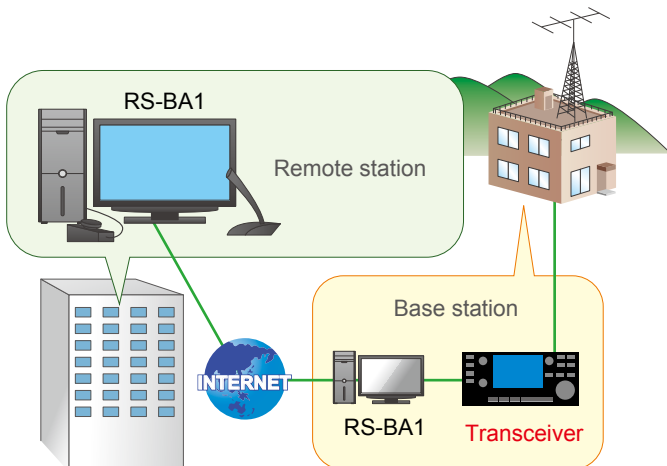

Examples of the remote control system

This section explains the minimum required settings to operate the transceiver through a cable, using the following illustration as an example.

You can also refer to each application's Help file for assistance with the functions and settings. While the application is open, push the [F1] key on the PC's keyboard to open the Help file.

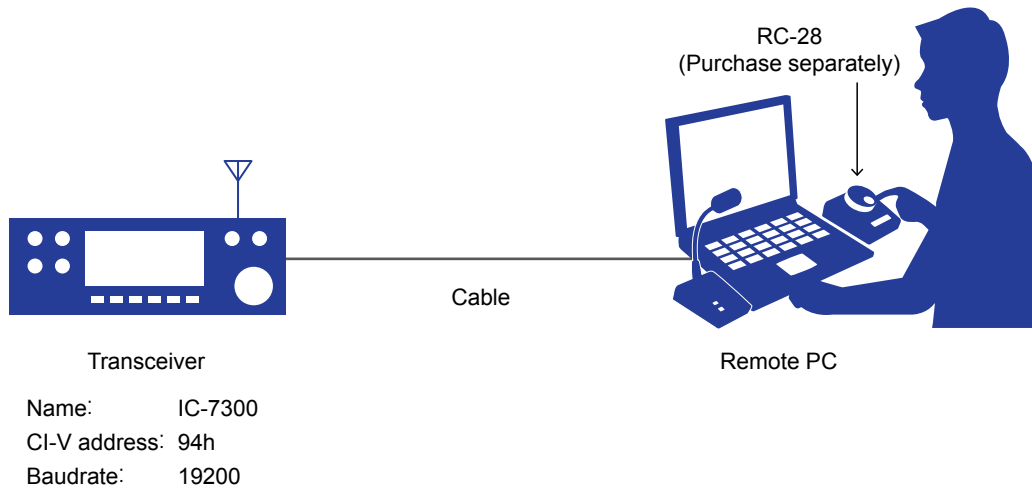

TIP: If you use an RC-28 REMOTE ENCODER connected to the Remote PC, you can use the RS-BA1 and feel like you are operating the actual transceiver's MAIN dial.

2 CONFIGURING THE SYSTEM THROUGH A CABLE

STEP 1. Select a connection method

Check the connector type on your transceiver and see the following chart to connect your transceiver to the PC. To connect an Icom CI-V command capable transceiver to the PC, you have to make connections for control command and audio communication.

① The RS-BA1 operation with the PC connected to the transceiver's ACC socket, MIC connector, or S/P DIF jack for audio communication cannot be guaranteed.

Transceiver's connector	Outline		Model	Ref.
	Control command	Audio		
[USB] port	Through a USB cable		IC-7100, IC-7200, IC-7300, IC-7410, IC-7600* ¹ , IC-7610, IC-7850, IC-7851, IC-9100	p. 2-3
[REMOTE] jack	Through the CT-17 CI-V LEVEL CONVERTER	Through an audio cable connected between the PC's audio terminal and the transceiver's [ACC] socket or [MIC] connector	All	p. 2-4
[RS-232C] connector	Through an RS-232C cable	Through an audio cable connected between the PC's audio terminal and the transceiver's [ACC] socket, [MIC] connector, or [S/P DIF] jack	IC-7700* ² , IC-7800* ²	p. 2-5

*¹ To turn the transceiver ON or OFF from the Remote Controller, connect to the transceiver's [REMOTE] jack.

*² To turn the transceiver ON or OFF from the Remote Controller, connect to the transceiver's [REMOTE] jack or directly connect to a LAN.

STEP 2. Connecting the transceiver to the PC

When connecting to the transceiver's [USB] port:

NOTE: For IC-7600 users

To turn the transceiver ON or OFF from the Remote Controller, connect to the transceiver's [REMOTE] jack. (p. 2-4)

- 1 System requirements**
- A PC that has a USB 1.1, 2.0, or 3.0 port
 - Icom CI-V command capable transceiver that has a [USB] port (Type B/Mini-B)
 - The USB cable (supplied with the RS-BA1 or a transceiver)

2 Install a USB driver.

CAUTION: DO NOT connect the transceiver to the PC with the USB cable until the USB driver installation has been completed. The driver is not supported by the Windows® automatic recognition system.

To use the USB cable between the transceiver and the PC, you must first install a USB driver. The USB driver comes with the RS-BA1. You can also download it from the Icom website.

NOTE: When a PC with USB 3.0 port is used to operate the transceiver, confirm the driver name. If the name "Silicon Laboratories CP210x USB to UART Bridge (Driver Removal)" is displayed on the Control Panel screen, uninstall it and then install the latest driver.

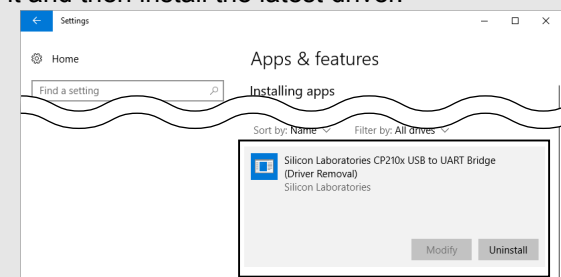

The latest driver and installation guide can be downloaded from here:
<http://www.icom.co.jp/world/index.html>
Read the installation guide before installing the driver.

- 3 Connect the transceiver to the PC.**
Connect the transceiver to the PC using the USB cable. This guide is based on using a Type B USB cable.

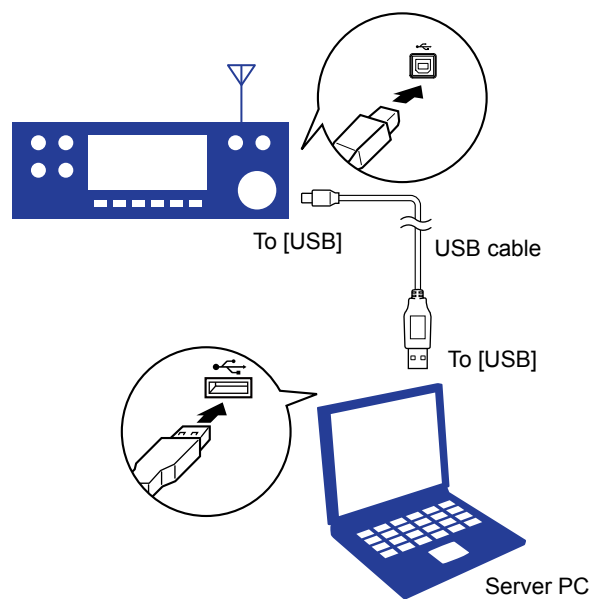

- NOTE:**
- If you connect a new USB audio device to your PC, the device selected as the default on your PC may be changed.
 - DO NOT connect another transceiver using a USB cable while the Remote Utility is open.

2 CONFIGURING THE SYSTEM THROUGH A CABLE

STEP 2. Connecting the transceiver to the PC

When connecting to the transceiver's [REMOTE] jack:

1 System requirements

- A PC that has an RS-232C connector
- Icom CI-V command capable transceiver that has a [REMOTE] jack
- The optional CT-17 CI-V LEVEL CONVERTER
 - ① Mini-plug cables are included
- An RS-232C cable (Supplied with the CT-17)
- Stereo audio cables (User supplied)

2 Connect a remote control system.

Connect the CT-17 to the PC, which enables the CI-V communication between them.

Icom transceivers

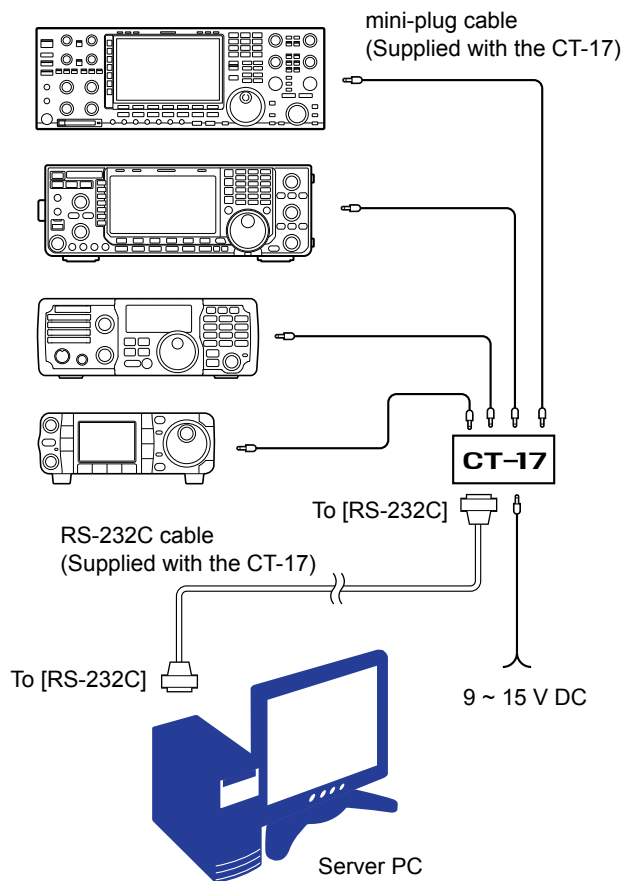

NOTE: The CT-17 accepts only an RS-232C cable. The use of an RS-232C-USB converter is not guaranteed.

3 Connecting an audio cables

Connect an audio cable between the PC's audio ports and the transceiver's [ACC] socket or [MIC] connector to enable audio communication between them.

- ① See the transceiver's instruction manual for details on the connector.

Transceiver

AF (Output)
MOD (Input)

PC

➔ LINE IN/MIC IN (Input)
➜ LINE OUT (Output)

- Connect to [ACC] (Rear panel view)

Example: IC-7600 (8 pin)

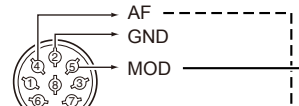

Example: IC-7000 (13 pin)

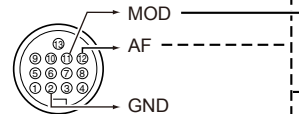

- Connect to [MIC] (Front panel view)

Example: IC-7600 (8 pin)

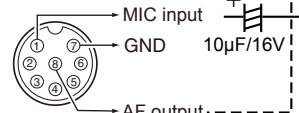

Example: IC-7000 (Rear panel view)

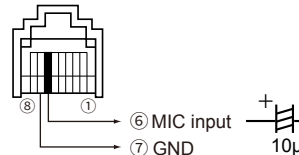

CAUTION:

- When using the [MIC] connector, **DO NOT** directly connect an audio cable between the transceiver's Microphone input and PC. It can cause a malfunction without adding the Electrolytic capacitor, as illustrated above.
- **DO NOT** connect a monaural plug to the PC's LINE OUT. It can cause a malfunction.

2 CONFIGURING THE SYSTEM THROUGH A CABLE

STEP 2. Connecting the transceiver to the PC

When connecting to a transceiver's [RS-232C] connector:

NOTE: For IC-7800 or IC-7700 users

To turn the transceiver ON or OFF from the Remote Controller, connect to the transceiver's [REMOTE] jack or directly connect to a LAN.

1 System requirements

- A PC that has an RS-232C connector
- Icom CI-V command capable transceiver that has an [RS-232C] connector
- An RS-232C cable (User supplied)
- Two S/P DIF digital cables or stereo audio cables (User supplied)

2

Connect a remote control system.

Connect an RS-232C cable between the transceiver and the PC.

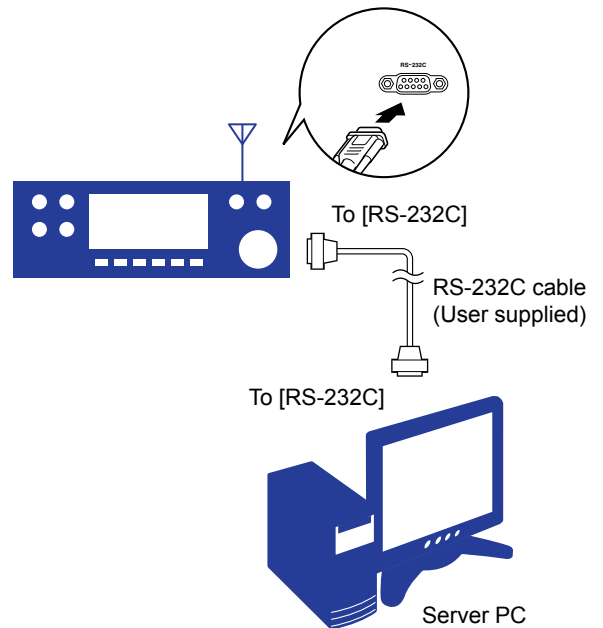

2 CONFIGURING THE SYSTEM THROUGH A CABLE

STEP 2. Connecting the transceiver to the PC

When connecting to the transceiver's [RS-232C] port (Continued):

3 Connecting an audio cables

Connect an audio cable between the PC's audio port and the transceiver's [S/PDIF] jack, [ACC] socket, or [MIC] connector to enable audio communication between them.

① See the transceiver's instruction manual for details on the transceiver's connector.

Using the [S/P DIF] jack

Transceiver		PC
S/PDIF OUT (Output)	➔	S/PDIF IN (Input)
S/PDIF IN (Input)	➔	S/PDIF OUT (Output)

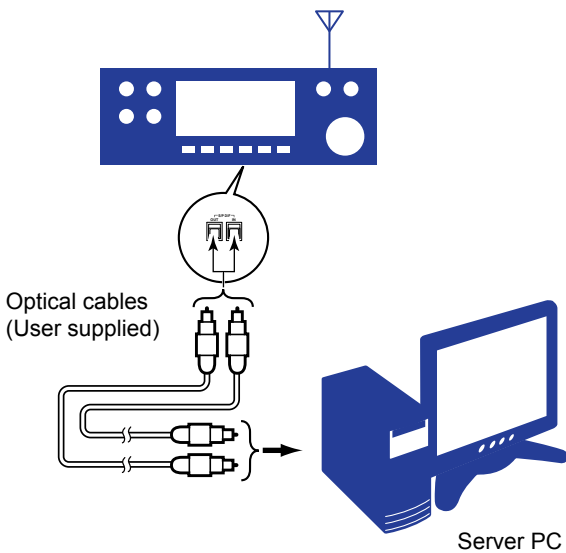

Using other than the [S/PDIF] jack

Transceiver		PC
AF (Output)	➔	LINE IN/MIC IN (Input)
MOD (Input)	➔	LINE OUT (Output)

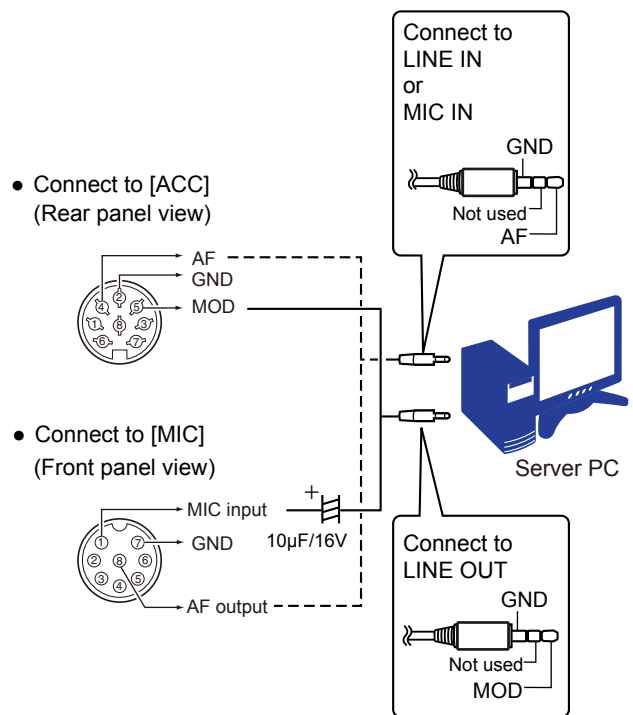

CAUTION:

- When using the [MIC] connector, **DO NOT** directly connect an audio cable between the transceiver's Microphone input and PC. It can cause a malfunction without adding the Electrolytic capacitor, as illustrated above.
- **DO NOT** connect a monaural plug to the PC's LINE OUT. It can cause a malfunction.

STEP 3. Setting the Remote Utility

This section describes how to setup the PC.

① Before configuring the settings, turn ON the transceiver.

1 Open the Remote Utility.

1. Open "Icom Remote Utility."
2. "Set your own PC information." is displayed, then click <OK>.
① When you first open the Remote Utility, this screen is displayed.

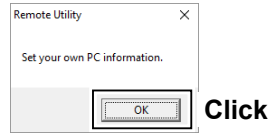

2 Configure the settings.

- ① When you first open the Remote Utility, this screen is displayed.
 1. Enter a name for your PC of up to 16 characters. (Example: Server PC)
① DO NOT use the same name for more than one PC on your network.
 2. Confirm the port numbers of the Control, Serial and Audio ports.
① Normally, use the default port numbers for these ports.
 3. Select your Internet access line type.
 4. Select the software display language.
① The selected language will be used as the Help file language.
 5. Click <Register> to save the settings.
 6. Click <OK>, and then restart the Remote Utility.

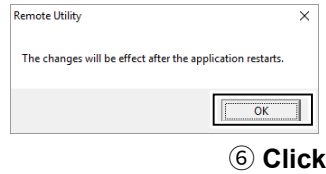
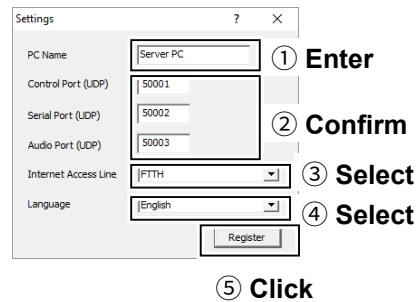

3 Click the Setup that you want to do.

- ① If no servers or no radios are registered, this screen is displayed.
Click "Setup for a Local PC (Directly connect the radio and PC)."

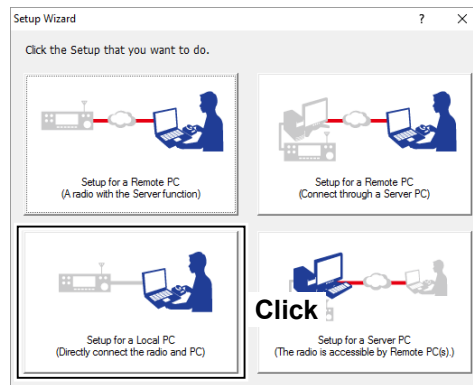

4 Start the Setup Wizard.

- Click <Next>.

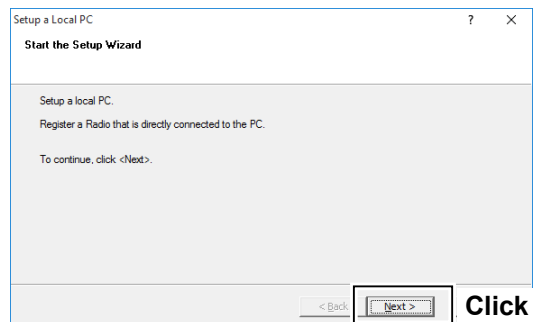

2 CONFIGURING THE SYSTEM THROUGH A CABLE

STEP 3. Setting the Remote Utility

5 Select a transceiver.

1. Select a transceiver that you want to add.
(Example: USB)
① If the transceiver is not listed, click <Search>.
① Select “Manual” if the transceiver is connected to the PC using other than a USB cable.
Select the connected transceiver from the drop-down list.
2. Click <Next>>.

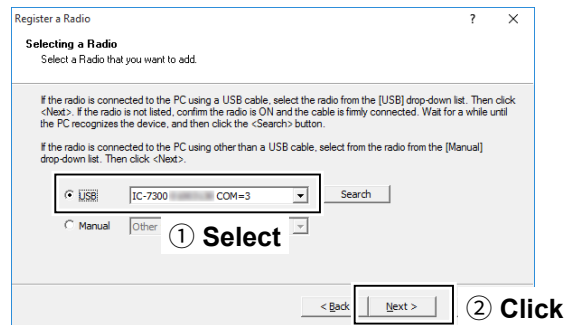

6 Set the CI-V/COM port settings.

1. Set the CI-V address, Baud rate, and COM Port Number.
① If you select “USB” in step 5, there are no necessary changes.
2. Click <Next>>.

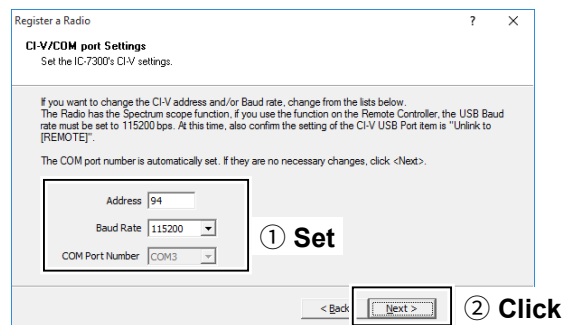

TIP: When you select “Manual” in step 5

The Audio Settings screen is displayed. Select the devices that input a received audio from the transceiver and output a modulation signal to the transceiver, and then click <Next>>.

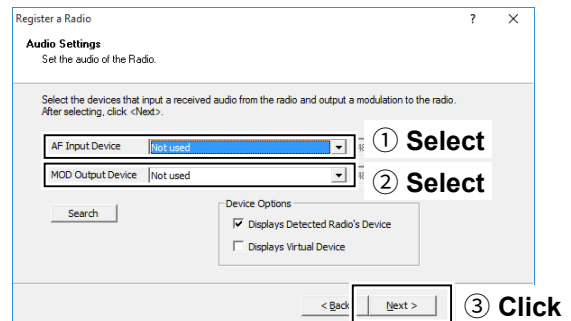

7 Enter the radio name.

1. Enter the radio name.
① The model name and the last 5 digits of the serial number are entered by default.
2. Click <Next>>.

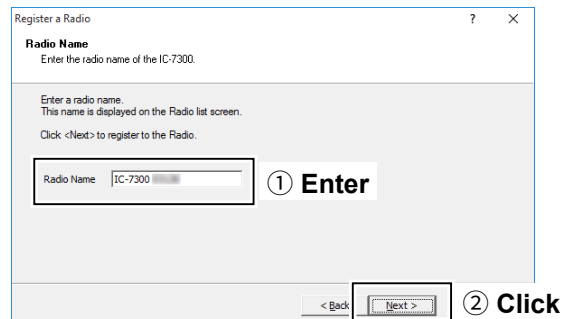

2 CONFIGURING THE SYSTEM THROUGH A CABLE

STEP 3. Setting the Remote Utility

8 The registration of the Radio is complete. Click <Finish>.

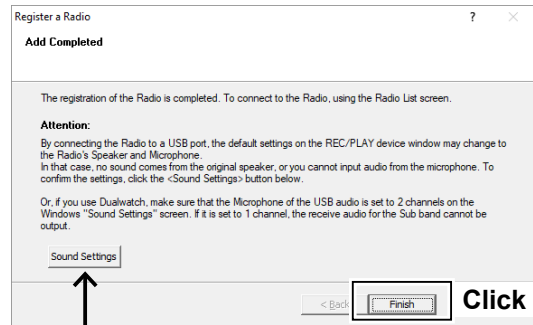

By connecting the transceiver to a USB port, the default settings on the REC/PLAY device window may change to the Radio's Speaker and Microphone. To confirm the settings, click <Sound Settings>.

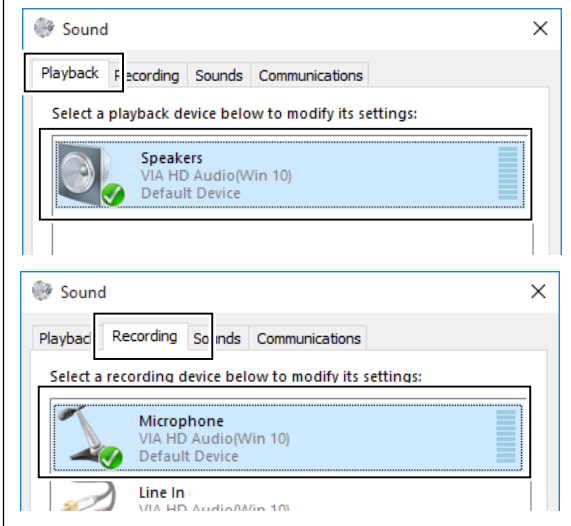

2 CONFIGURING THE SYSTEM THROUGH A CABLE

STEP 3. Setting the Remote Utility

9 Connect the transceiver.

1. Click <Connect>.
 - The dialog that notifies the virtual serial port is displayed.
 - ① If the connection fails, and an error screen is displayed, solve the problem. (p. 7-2)
2. Click <OK>.
 - “<<Connected>>” is displayed under the radio name when the connection has succeeded.

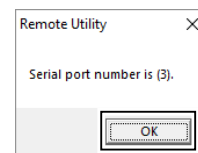
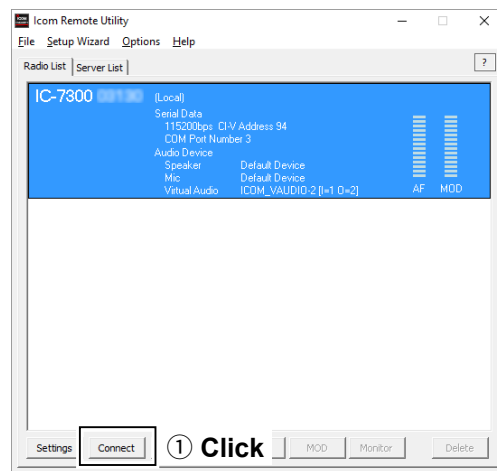



STEP 4. Starting the Remote control operation

This section describes how to connect and remotely control a transceiver from a PC using the Remote Controller.

The description in this section is based on the assumption that:

- The transceiver is turned ON.
- The connection to the transceiver using the Remote Utility has succeeded.
(“<<Connected>>” is displayed under the radio name.)

1 Connect setting using the Remote Controller application

1. Open “RS-BA1 Remote Control Ver2.”
2. Click  in the toolbar, or click “Connect Setting...” in the Option menu.
 - The Connect Setting screen is displayed.
 - ① You cannot change the settings while the transceiver is connected to the Remote Controller.
3. Select a transceiver to access using the Remote Utility application, in **Model**.
(Example: IC-7300 (Ver1.20 -))
4. Select the connection between the transceiver and PC in **Connection**.
(Example: USB)
 - ① If the “MOD Select has also been changed.” dialog may be displayed. Click <OK>.
 - ① The confirmation dialog for the connection setting may be displayed, depending on the transceiver. If connected correctly, click <OK>.
5. Select a transceiver to access using the Remote Utility application, in **Remote Utility**.
(Example: IC-7300 XXXXX)
 - The CI-V settings are automatically loaded from the Remote Utility application to **CI-V**. The settings include the virtual COM Port number, transceiver’s CI-V address, and baud rate.
 - ① If the desired transceiver is not displayed in **Remote Utility**, click <Search> to load the transceiver’s information from the Remote Utility application.
6. Check “**Software closing turns OFF the Radio.**” to turn OFF the transceiver when the Remote Controller application is closed by clicking  or “Exit” on the File menu.
 - ① When the PC shuts down while the Remote Controller application is still running, the transceiver’s power may not turn OFF.
 - ① For other settings, see the Remote Controller’s Help file.
7. Click <OK> to save the settings and close the screen.

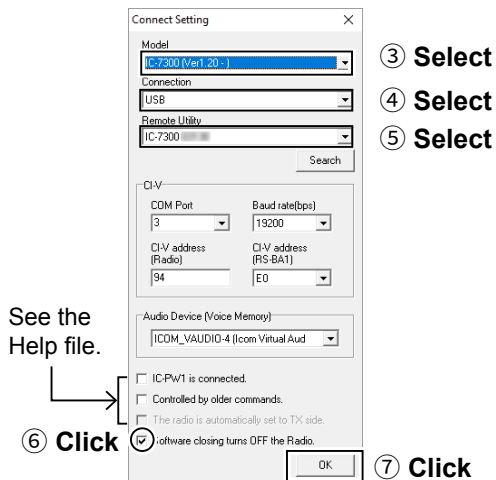

2 CONFIGURING THE SYSTEM THROUGH A CABLE

STEP 4. Starting the Remote control operation

2 Connecting to the transceiver using the Remote Controller application

- Click <  > in the toolbar, or click “Connect ON” in the File menu.
- When the connection has succeeded, the transceiver’s current data will be displayed on the main panel.

3 Selecting a modulation input connector

To transmit audio when remotely controlling the transceiver from the Remote Controller, configure the following settings, depending on the transceiver’s connector.

1. Click <MIC SET> on the Remote Controller.
 - The MIC SET screen is displayed.
2. Select a connector in **MOD Select (Remote ON)** (Example: USB), to input transmit audio from the PC to the transceiver.
3. Click the close button to close the screen.

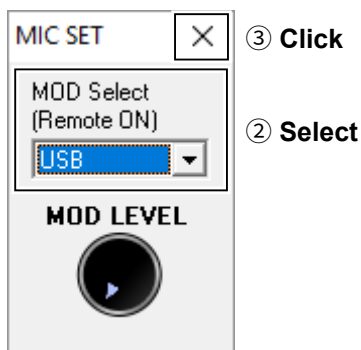

4 Remote control operation

See the RS-BA1 Remote Controller’s Help file for remote operation details, such as how to change the frequency or how to turn ON each function.

- ① To display the Help file, click “Contents” in the Help menu on the Remote Controller application, or push the [F1] key on your PC’s keyboard.

NOTE:

- **DO NOT** allow the PC to go into the sleep or standby mode while using the RS-BA1. Otherwise, it might not work properly after the PC resumes normal activity.
- **When not using the transceiver:**
Follow the steps below to finish the remote control operation.
 1. Disconnect the transceiver from the Remote Controller application, and then close the Remote Controller application.
 2. Disconnect the transceiver from the Remote Utility application, and then close the Remote Utility application.
 3. Turn OFF the transceiver and the PC.
 - ① If you check **Software closing turns OFF the Radio.**, when you close the Remote Controller, the transceiver is also turned OFF.
- When you manually select the transmit audio input connectors to be used after finishing the remote control operation, right-click  in the toolbar, or click “Remote Setting...” in the File menu to select.
 - ① Regularly, it automatically returns to the original setting before you start the remote control operation.

TIP: Importing the repeater list

You can easily set the DV mode repeater information by importing the repeater list preset for each transceiver. See the RS-BA1 Remote Controller’s Help file for importing details.

Examples of the remote control system

This section explains the minimum required settings to configure a remote control system through a LAN, using the following illustrations as examples.

- ① Only the Remote PC users whose ID and password are registered to the Base station transceiver or the Server PC can connect to it. **BE CAREFUL** in managing IDs and passwords.
- ① You can also refer to each application's Help file for assistance with the functions and settings. While the application is open, push the [F1] key on the PC's keyboard to open the Help file.

A. When using a transceiver with the Server function (p. 3-2)

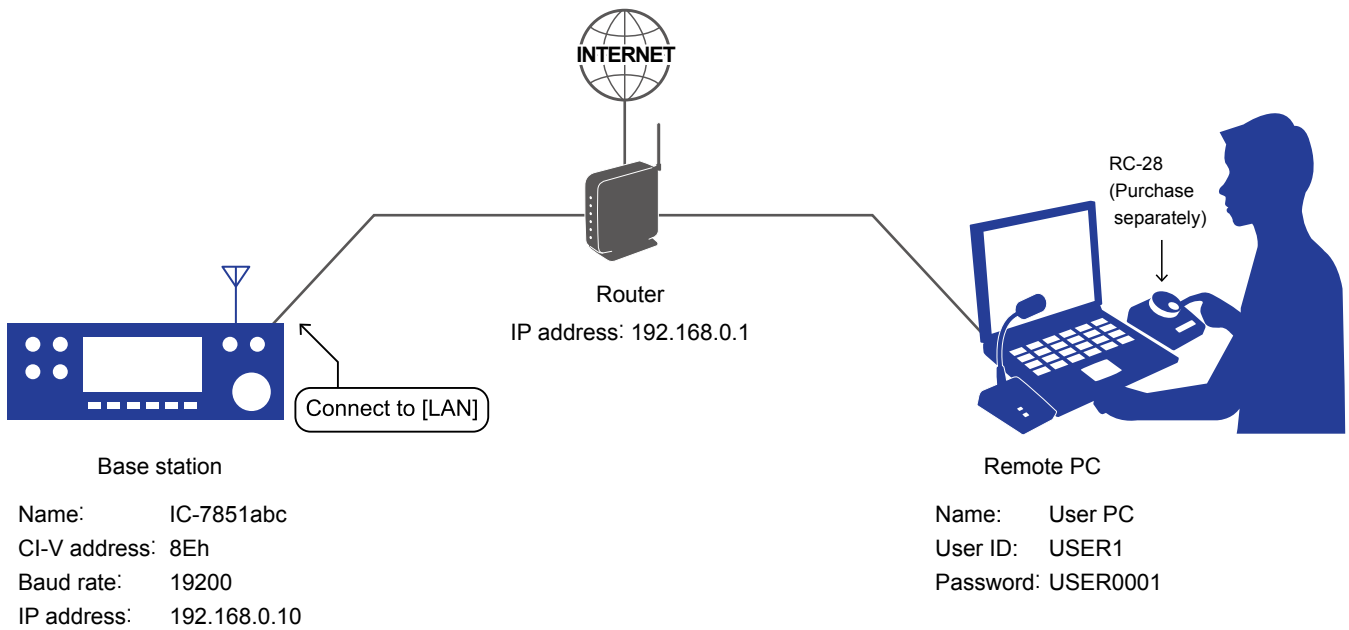

B. When using the Server PC (p. 3-4)

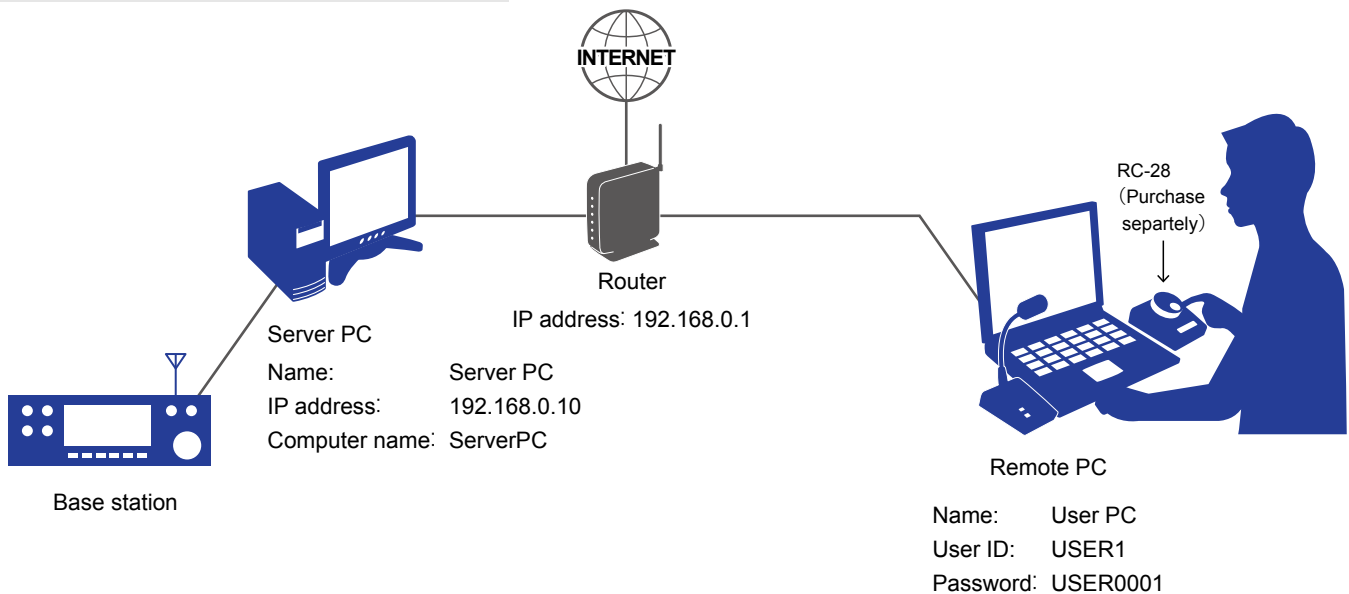

- ① The user ID, password, and other settings in these illustrations are only examples. Configure the system using your own settings.

TIP: If you use an RC-28 REMOTE ENCODER connected to the Remote PC, you can use the RS-BA1 and feel like you are using the actual transceiver's MAIN dial.

STEP 1. Settings on the Base station

◇ A. When using a transceiver with the Server function

Set each setting item on the Base station transceiver.

① If you want to connect to the Internet and remotely control the transceiver, see Section 4.

NOTE: When you change a setting that displays “(Valid after Restart),” you must restart the transceiver after setting. After restarting, keep the transceiver’s power ON or remain in the remote standby mode.

Network setting

Items	Contents
DHCP*	ON (Default)
Network Name*	A Network Name Example: IC-7851
Network Control	OFF (Default) → ON
Control Port (UDP)	50001 (Default)
Serial Port (UDP)	50002 (Default)
Audio Port (UDP)	50003 (Default)
Internet Access Line	Your Internet access line type Example: FTTH (Default)

* If you set **DHCP** to “OFF” to use the IP address instead of the network name, or you use an IC-7800 or IC-7700, set the items shown below.

Items	Contents
IP Address	An IP address that is not assigned to any other device. Example: 192.168.0.10 (Default)
Default Gateway	An IP address of the LAN side on the router Example: 192.168.0.1

Transceiver registration

Items	Contents
Network Radio Name	A Network Radio Name ① Up to 16 characters Example: IC-7851abc

Transmit audio setting (For the IC-7800 and IC-7700)

Items	Contents
Network MOD Use	ON (Default)

3 CONFIGURING THE SYSTEM THROUGH A LAN

STEP 1. Settings on the Base station

◇ A. When using a transceiver with the Server function (Continued)

User registration

Items	Contents
Network User1/2/3* ID	A User ID ① Up to 16 characters Example: USER1
Network User1/2/3* Password	A Password ① 8 ~ 16 characters ① At least 2 different characters must be used. Example: USER0001
Network User1/2/3* Administrator	NO (Default) → YES ① When the user is set as an administrator.

* There is no User3 in the IC-7610.

NOTE: To prevent unauthorized access

Set a long and strong password so that no one can possibly guess it. Mix upper and lower case letters, numbers or characters. Periodically changing the password is recommended.

TIP: Standby mode setting

To remotely control the transceiver using the RS-BA1, the transceiver should be turned ON or be in the standby mode.

To set the transceiver in the standby mode, set the item described below and select "Standby (for Remote Control)" on the displayed screen when you turn OFF the transceiver.

① The LED above [POWER] slowly blinks orange if the transceiver is in the standby mode.

Items	Contents
Shutdown Function (Except for the IC-7610)	Standby/Shutdown
Power OFF Setting (for Remote Control) (For the IC-7610)	

NOTE: Before "STEP 2. Settings on the Remote PC's Remote Utility application" (p. 3-10)

Confirm the transceiver settings described below.

- Network Name or IP Address
- Network User ID and Password

① Keep the transceiver's power ON, or remain in the Remote Standby mode

3 CONFIGURING THE SYSTEM THROUGH A LAN

STEP 1. Settings on the Base station

◇ B. When using the Server PC

Connect the transceiver to the Server PC and setup the Remote Utility.

① If you want to connect to the Internet and remotely control the transceiver, see Section 4.

- 1 Connect the transceiver to the Server PC.**
Connect the transceiver to the Server PC with a cable.
① See page 2-2 about the connection.

- 2 Open the Remote Utility.**
 1. Open "Icom Remote Utility."
 2. "Set your own PC information." is displayed, then click <OK>.
① When you first open the Remote Utility, this screen is displayed.

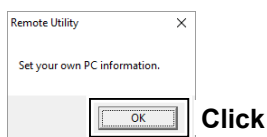

- 3 Configure the settings.**
 - ① When you first open the Remote Utility, this screen is displayed.
 1. Enter a name for your PC of up to 16 characters. (Example: Server PC)
① **DO NOT** use the same name for more than one PC on your network.
 2. Confirm the port numbers of the Control, Serial and Audio ports.
① You should use the default port numbers for these ports.
 3. Select your internet access line type.
 4. Select the software display language.
① The selected language will be used as the Help file language.
 5. Click <Register> to save the settings.
 6. Click <OK>, and then restart the Remote Utility.

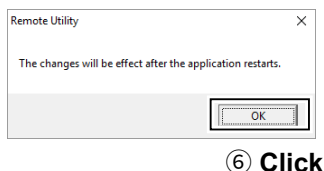
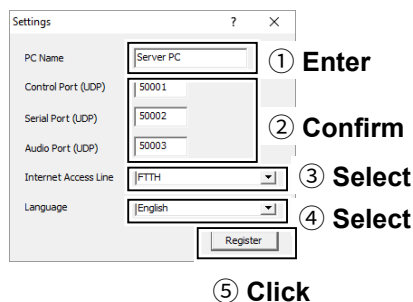

- 4 Click the Setup that you want to do.**
 - ① If no Servers and no transceivers are registered, this screen is displayed.
Click "Setup for a Server PC (The radio is accessible by Remote PC(s))."

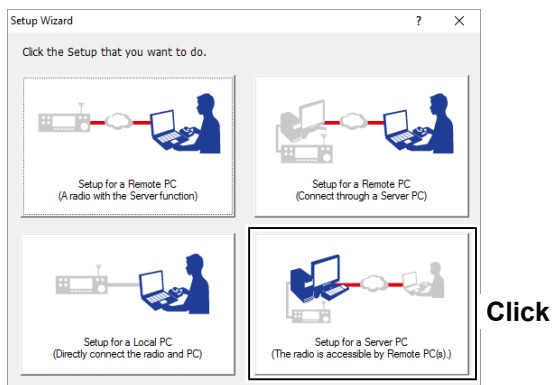

- 5 Start the Setup Wizard.**
Click <Next>.

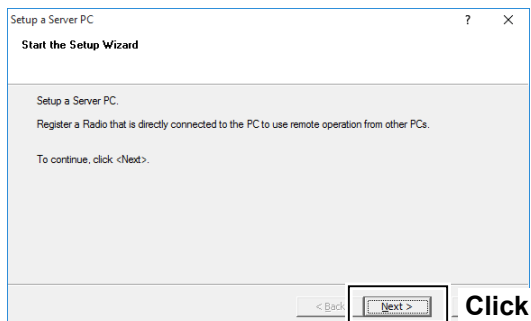

3 CONFIGURING THE SYSTEM THROUGH A LAN

STEP 1. Settings on the Base station

◇ B. When using the Server PC (Continued)

- 6 Select a Radio for the Remote operation.**
1. Select a transceiver that you want to add.
 - ① If the transceiver has already been registered, select “Registered radios” and select it from the drop-down list.
 2. Click <Next>>.

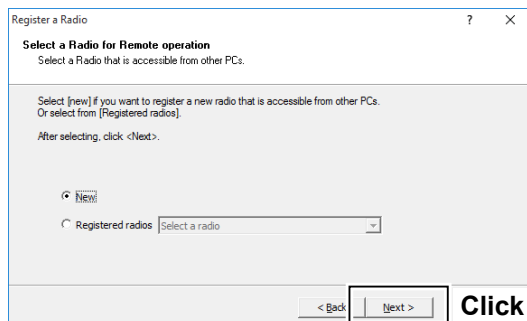

- 7 Selecting a Radio**
- ① If you select “Registered radios” in step 6, go to the next page (step 9).
 1. Select a connection type (Example: USB).
 - ① If the transceivers are not listed, click <Search>.
 - ① Select “Manual” if the transceiver is connected to the PC using other than a USB cable. Select the connected transceiver from the drop-down list.
 2. Click <Next>>.

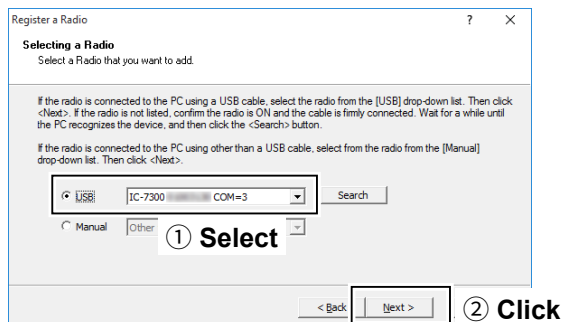

- 8 Set the CI-V/COM port settings.**
- ① If you select “Registered radios” in step 6, go to the next page (step 9).
 1. Set the CI-V address, Baud Rate, and COM Port Number.
 - ① If you select “USB” in step 5, there are no necessary changes.
 2. Click <Next>>.

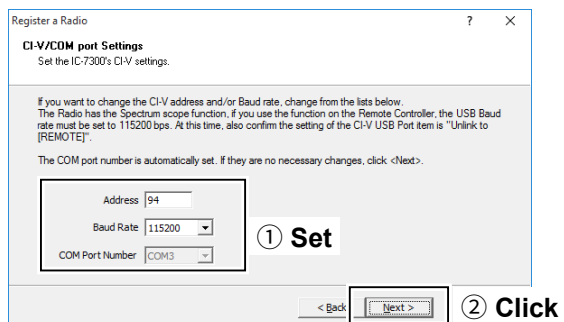

3 CONFIGURING THE SYSTEM THROUGH A LAN

STEP 1. Settings on the Base station

◇ B. When using the Server PC (Continued)

When you select “Manual” in step 7:
 The Audio Settings screen is displayed.
 Select the devices that input a received audio from the transceiver and output a modulation to the transceiver, and then click <Next>.

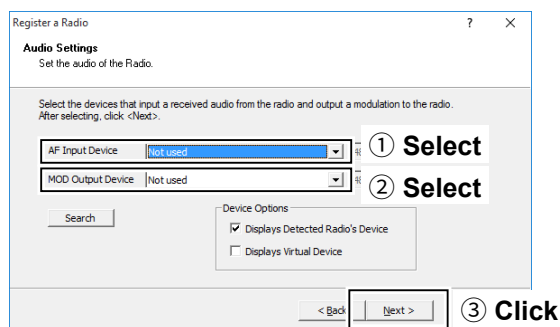

9 Register a User to allow a connection.

1. Click <Add>.
 - The Add User screen is displayed.
2. Enter a User ID. (Example: USER1)
3. Enter a password of more than 8 characters. (Example: USER0001)
4. Click <OK>.
5. Select a registered user.
6. Click <Add >>>.
7. Click <Next >>.

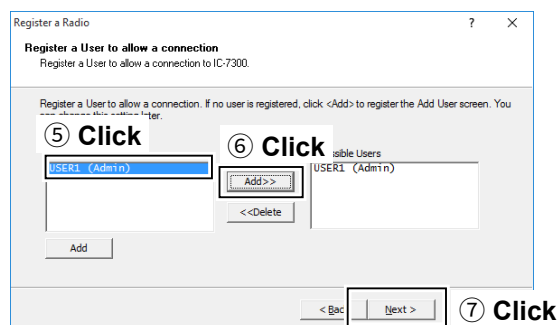
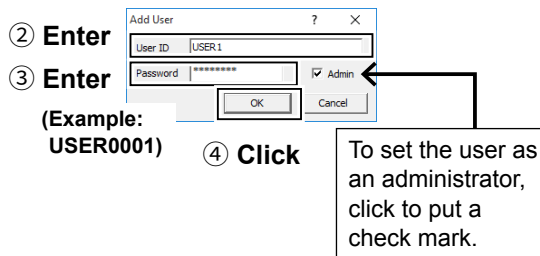
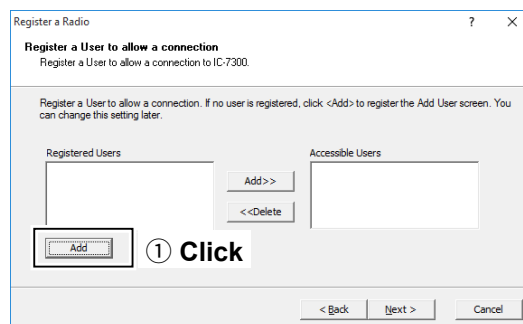

NOTE: To prevent unauthorized access

Set a long and strong password so that no one can possibly guess it. Mix upper and lower case letters, numbers or characters. Periodically changing the password is recommended.

3 CONFIGURING THE SYSTEM THROUGH A LAN

STEP 1. Settings on the Base station

◇ B. When using the Server PC (Continued)

10 Enter the radio name.

1. Enter the radio name.
① The radio's model name and the last 5 digits of the serial number is entered by default.
2. Click <Next>.

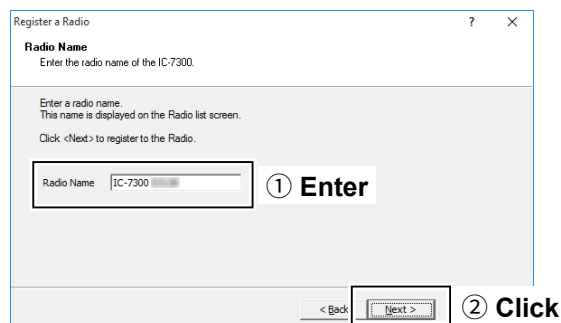

11 The registration of the Radio is completed.

1. Click <Finish>.

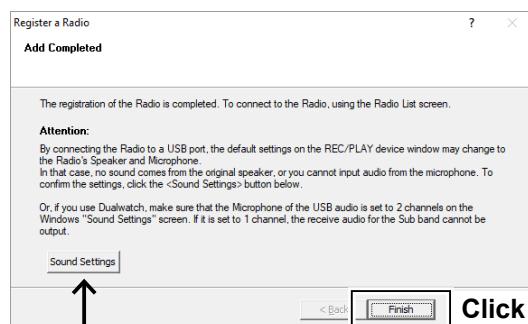

By connecting the transceiver to a USB port, the default settings on the REC/PLAY device window may change to the Radio's Speaker and Microphone. To confirm the settings, click <Sound Settings>.

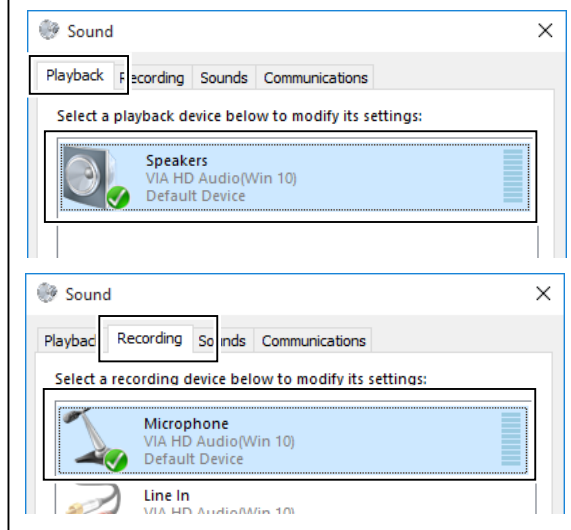

NOTE: Before "Step 2. Settings on the Remote PC's Remote Utility application"

Confirm the Server PC settings described below.

- PC name or IP Address
- User ID and Password registered to the Remote Utility
- ① Keep the transceiver's power ON and open the Remote Utility.

3 CONFIGURING THE SYSTEM THROUGH A LAN

STEP 1. Settings on the Base station

◇ B. When using the Server PC (Continued)

TIP: Server PC name and IP address

If you configure the remote control system through a LAN, Remote stations can access the server using the Server PC's computer name or IP address.

A computer name is used on networks to identify a particular workstation on the network.

The example below describes how to find out the Server PC's computer name or IP address to be requested by Remote stations. Find out your PC's computer name.

1. Click the folder icon on the taskbar.



2. Right-click "This PC," and then click "Properties."

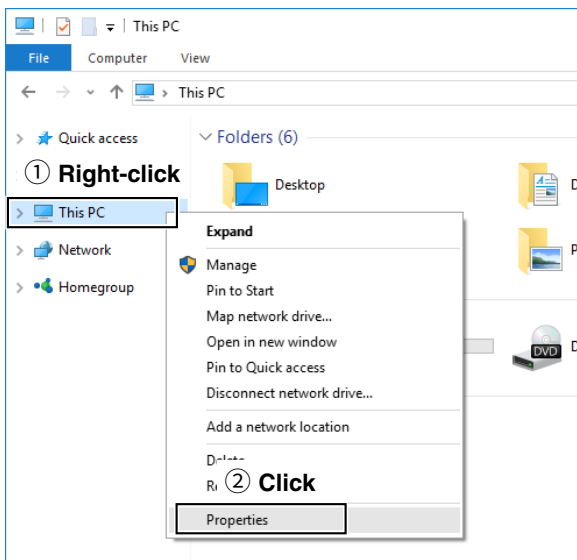

3. The "System" screen is displayed. Confirm the name that is displayed in **Computer name**.

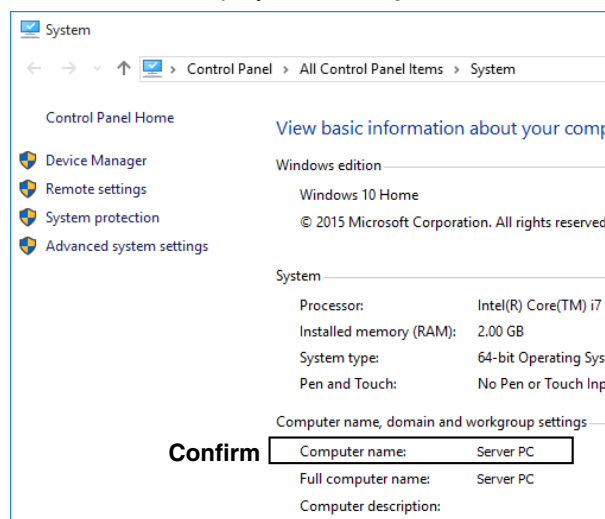

3 CONFIGURING THE SYSTEM THROUGH A LAN

STEP 1. Settings on the Base station

◇ B. When using the Server PC (Continued)

TIP: Server PC name and IP address (continued)

An IP address is a numerical label that is assigned to devices participating in a computer network. Find out your PC's IP address.

1. Right-click the Network icon on the taskbar, and then click "Open Network & Internet settings."

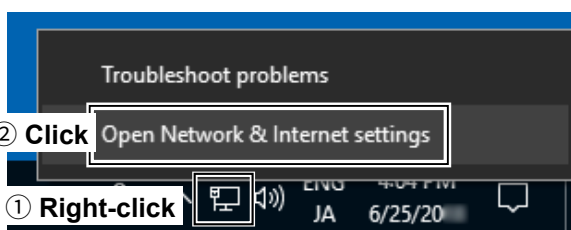

- ① When using Windows 8.1 or Windows 7, click "Open Network and Sharing Center" and go to step 3.
2. Click "Network and Sharing Center."

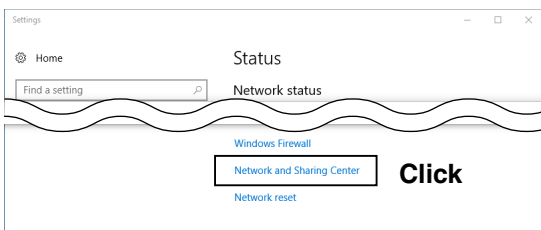

3. The Network and Sharing Center screen is displayed, and then click "Ethernet."

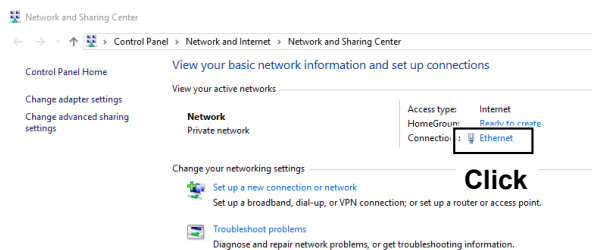

4. The Ethernet Status screen is displayed, and then click <Details...>.

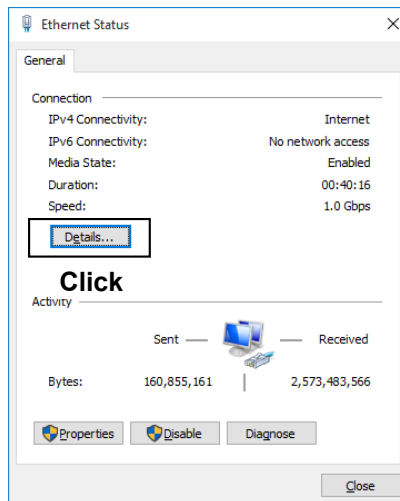

5. The Network Connection Details screen is displayed, and then confirm the IP address that is displayed in the Address field. Click <Close> to close the window.

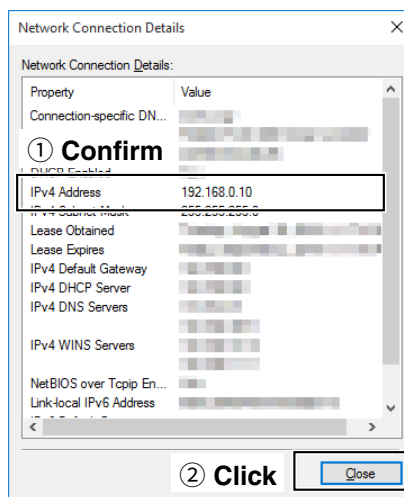

TIP: When **DHCP Enabled** is set to "Yes" in the Network Connection Details screen, the DHCP server assigns a dynamic IP address to your PC. Therefore, Remote stations have to match the IP address each time to access the Server PC.

If **DHCP Enabled** is set to "Yes," we recommend that you let Remote stations access the Server PC using its computer name.

3 CONFIGURING THE SYSTEM THROUGH A LAN

STEP 2. Settings on the Remote PC's Remote Utility application

This section describes how to setup the Remote PC.

① Before configuring the settings, connect a speaker and microphone or headset to the PC.

1 Open the Remote Utility.

1. Open "Icom Remote Utility."
2. "Set your own PC information." is displayed, then click <OK>.
① When you first open the Remote Utility, this screen is displayed.

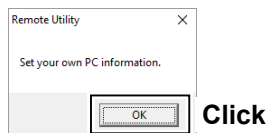

2 Configure the settings.

- ① When you first open the Remote Utility, this screen is displayed.
 1. Enter a name for your PC of up to 16 characters. (Example: User PC)
① DO NOT use the same name for more than one PC on your network.
 2. Confirm the port numbers of the Control, Serial and Audio ports.
① You should use the default port numbers for these ports.
 3. Select your Internet access line type.
 4. Select the software display language.
① The selected language will be used as the Help file language.
 5. Click <Register> to save the settings.
 6. Click <OK>, and then restart the Remote Utility.

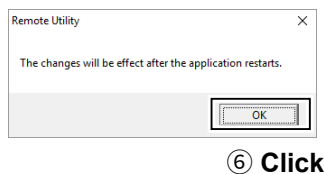
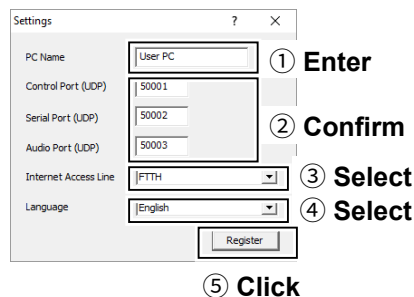

3 Click the Setup that you want to do.

- ① If no servers nor no radios are registered, this screen is displayed.
Click "Setup for a Remote PC (A radio with the Server function)" or "Setup for a Remote PC (Connect through a Server PC)."
① Example: "Setup for a Remote PC (A radio with the Server function)"

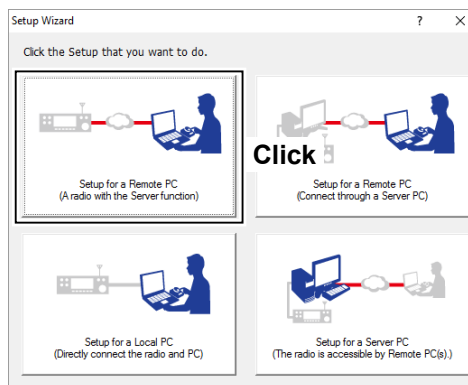

4 Start the Setup Wizard.

Click <Next>.

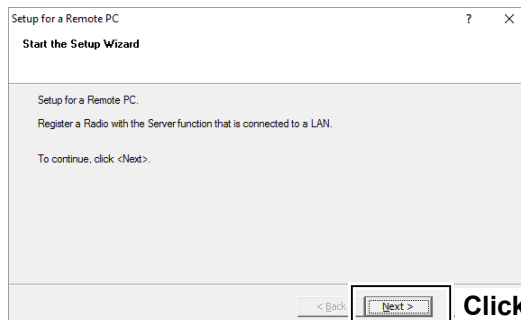

3 CONFIGURING THE SYSTEM THROUGH A LAN

STEP 2. Settings on the Remote PC's Remote Utility application

5 Enter the Server Information.

1. Enter the transceiver Network Name or IP Address.
 - ① When using a Server PC, enter the Server PC's computer name or IP address. (p. 3-8)
2. Confirm the Control Port number.
 - ① You should use the default port number for this port.
3. Click <Next>>.

Server Address or Network Name: IC-7851

Control Port (UDP): 50001

① Enter

② Confirm

< Back Next >

③ Click

6 Enter the User ID and Password.

1. Enter the User ID and Password that are registered to the transceiver.
2. Click <Next>>.
 - After clicking <Next>>, connects to the server.

User ID: USER1

Password: *****

① Enter

② Enter

(Example: USER0001)

< Back Next >

③ Click

TIP: If you cannot connect to the server, an error dialog is displayed. Click <<Back>, and confirm the settings.

The Server Connection failed

The Server is not found. Cannot connect to the Server.
Click <Back> and confirm the Server address or Network name.
Or click <Next> to save the Server.

< Back Next > Cancel

7 Adding the Server has been completed.

1. Enter the Server Description.
 - ① The Server Address or Network Name is entered by default.
2. Click <Finish>.

Server Description: IC-7851

① Enter

The following radios that are registered to the Server are added to the Radio List.
To connect to the radio, using the Radio List screen.
-IC-7851abc

< Back Finish

② Click

3 CONFIGURING THE SYSTEM THROUGH A LAN

STEP 2. Settings on the Remote PC's Remote Utility application

8 Configure the settings to connect to the transceiver.

1. Select the transceiver.
2. Click <Settings>.
3. Click <Recommended>.
 - The Select Network screen is displayed.
4. Select **LAN**.
5. Click <Next>.
 - The recommended values for your network are displayed.
6. Click <Yes> to automatically set the displayed values in each field of the Network Setting, then close the Select Network screen.
7. Select a virtual COM port number.
 - ① The selected COM port number is used for CI-V operation with the transceiver.
 - ① When you connect to the transceiver with the Remote Controller, you have to set the COM port number.
8. Select an audio device in **Speaker** that your speaker is connected, to output the received audio from the network.
9. Select an audio device in **Mic** that your microphone is connected, to transmit the input audio to the network.
10. Click <OK>.

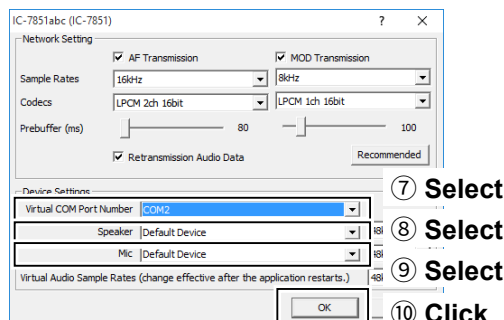
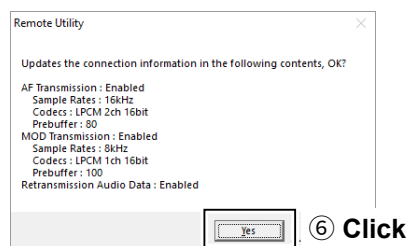
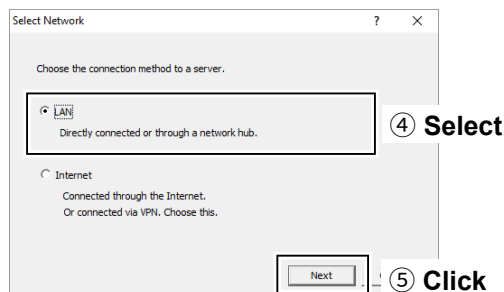
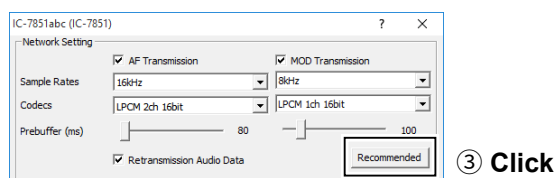
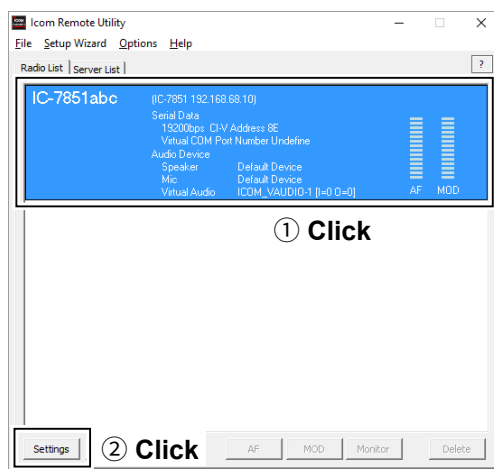

3 CONFIGURING THE SYSTEM THROUGH A LAN

STEP 2. Settings on the Remote PC's Remote Utility application

9 Connect the transceiver.

1. Click <Connect>.
 - The dialog that indicates the virtual serial port is displayed.
 - ① If the connection fails, and an error screen is displayed, solve the problem. (p. 7-2)
2. Click <OK>.
 - “<<Connected>>” is displayed under the radio name when the connection has succeeded.

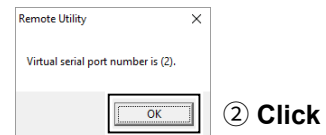
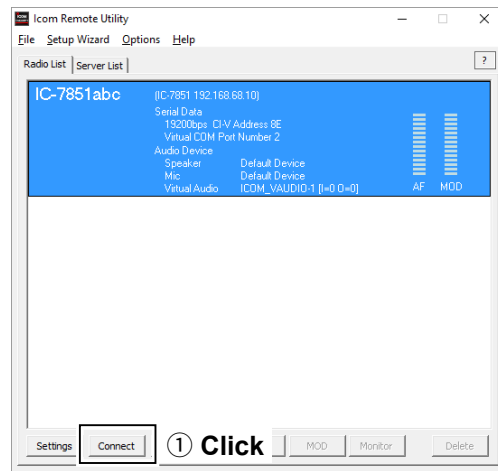



STEP 3. Starting the Remote control operation

This section describes how to connect and start remotely controlling a transceiver from a Remote PC using the Remote Controller.

The description in this section is based on the assumption that the connection to the transceiver using the Remote Utility has succeeded. (“<<Connected>>” is displayed under the radio name.)

1 Connect setting using the Remote Controller application

1. Open “RS-BA1 Remote Control Version 2.”
2. Click  in the toolbar, or click “Connect Setting...” in the Option menu.
 - The Connect Setting screen is displayed.
 - ① You cannot change the settings while the transceiver is connected to the Remote Controller.
3. Select a transceiver to access using the Remote Utility application, in **Model**.
(Example: IC-7851 (Ver1.30 -) (DUAL))
4. Select the connection between the transceiver and PC in **Connection**. (Example: LAN)
 - ① When the “MOD Select has also been changed.” dialog is displayed, click <OK>.
 - ① The confirmation dialog for the connection setting may be displayed, depending on the transceiver. If connected correctly, click <OK>.
5. Select a transceiver to access using the Remote Utility application, in **Remote Utility**.
(Example: IC-7851abc)
 - The CI-V settings are automatically loaded from the Remote Utility application to **CI-V**. The settings include the virtual COM Port number, transceiver’s CI-V address, and baud rate.
 - ① If the desired transceiver is not displayed in **Remote Utility**, click <Search> to load the transceiver’s information from the Remote Utility application.
6. Check “**Software closing turns OFF the Radio.**” to turn OFF the transceiver when the Remote Controller application is closed by clicking  or “Exit” on the File menu.
 - ① When you shut down the PC while the Remote Controller application is still running, the transceiver may not be turned OFF.
 - ① For other settings, see the Remote Controller’s Help file.
7. Click <OK> to save the settings and close the screen.



3 CONFIGURING THE SYSTEM THROUGH A LAN

STEP 3. Starting the Remote control operation

2 Connecting to the transceiver using the Remote Controller application

- Click <  > in the toolbar, or click “Connect ON” in the File menu.
- When the connection has succeeded, the transceiver’s current data will be displayed on the main panel.

3 Selecting a modulation input connector

To transmit audio when remotely controlling the transceiver from the Remote Controller, configure the following settings, depending on the transceiver’s connector.

1. Click <MIC SET> on the Remote Controller.
 - The MIC SET screen is displayed.
2. Select an appropriate connector in **MOD Select (Remote ON)** (Example: LAN), to input transmit audio from the PC to the transceiver.
3. Click the close button to close the screen.

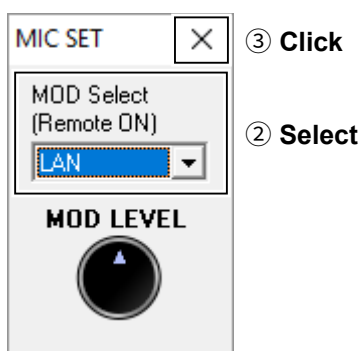

4 Remote control operation

See the RS-BA1 Remote Controller’s Help file for remote operation details, such as how to change the frequency or how to turn ON each function.

To display the Help file, click “Contents” in the Help menu on the Remote Controller application, or push the [F1] key on your PC’s keyboard.

NOTE:

- **DO NOT** allow the PC to go into the sleep or standby mode while using the RS-BA1. Otherwise, it might not work properly after the PC resumes normal activity.
- **When not using the transceiver:**
Follow the steps below to finish the remote control operation.
 1. Disconnect the transceiver from the Remote Controller application, and then close the Remote Controller application.
 2. Disconnect the transceiver from the Remote Utility application, and then close the Remote Utility application.
 3. Turn OFF the transceiver and the PC.
 - ① If you check **Software closing turns OFF the Radio.**, when you close the Remote Controller, the transceiver is also turned OFF.
- When you manually select the transmit audio input connectors to be used after finishing the remote control operation, right-click  in the toolbar, or click “Remote Setting...” in the File menu to select.
 - ① Regularly, it automatically returns to the original setting before you start the remote control operation.

TIP: Importing the repeater list

You can easily set the DV mode repeater information by importing the repeater list preset for each transceiver. See the RS-BA1 Remote Controller’s Help file for importing details.

Examples of the remote control system through the Internet

This section explains the minimum required settings to configure a remote control system through the Internet, using the following illustrations as examples.

- ① Only the Remote PC users whose ID and password are registered to the Base station transceiver or the Server PC can connect to it. **BE CAREFUL** in managing IDs and passwords.
- ① You can also refer to each application's help file for assistance with the functions and settings. While the application is open, push the [F1] key on the PC's keyboard to open the help file.

A. When using the transceiver with the Server function (p. 4-5)

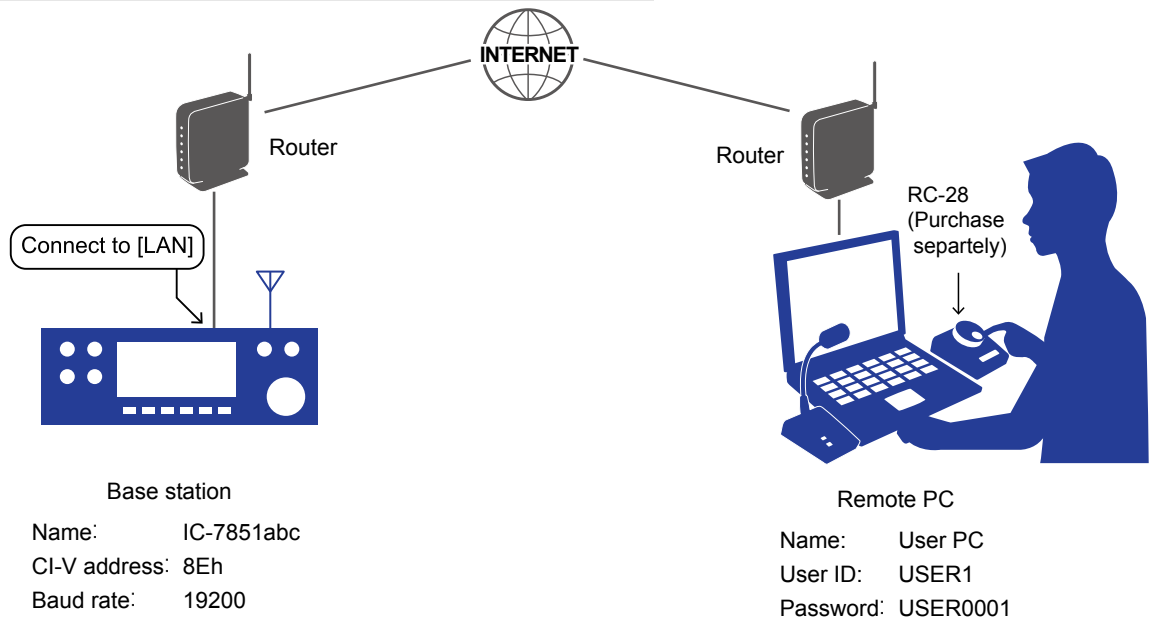

B. When using the Server PC (p. 4-7)

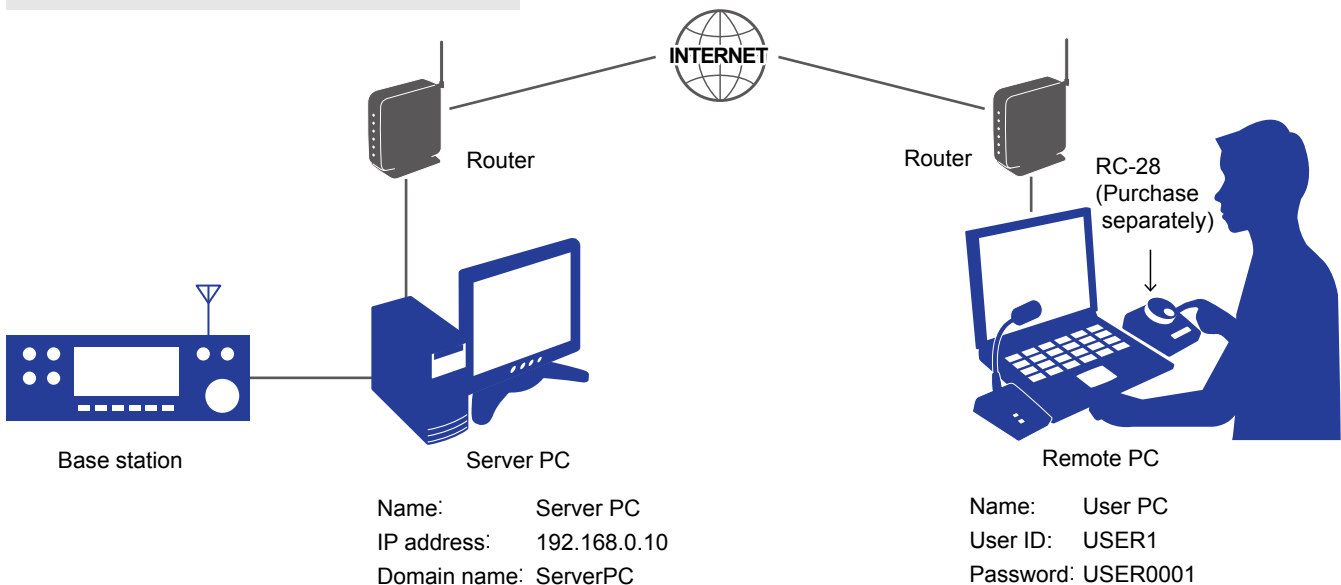

- ① The user ID, password, and other settings in these illustrations are only examples. Configure the system using your own settings.

TIP: If you use an RC-28 REMOTE ENCODER connected to the Remote PC, you can use the RS-BA1 and feel like you are using the actual transceiver's MAIN dial.

About a public IP address and the Dynamic DNS service

If you configure the remote control system through the Internet, PCs can connect to the transceiver using its public IP address or domain name.

◇ To let PCs connect to the Base station using its public IP address

A public IP address is an address that is accessible over the global Internet. Check the router’s manual about how to configure your router to set the public IP address.

NOTE:

- If you have a dynamic public IP address, we recommend that you use the Dynamic DNS service to enable the PCs to connect to the transceiver.
- If the PC connected to the transceiver is not using the Dynamic DNS service, you need to change setting of PC’s Remote Utility to connect to the transceiver each time its public IP address changes.

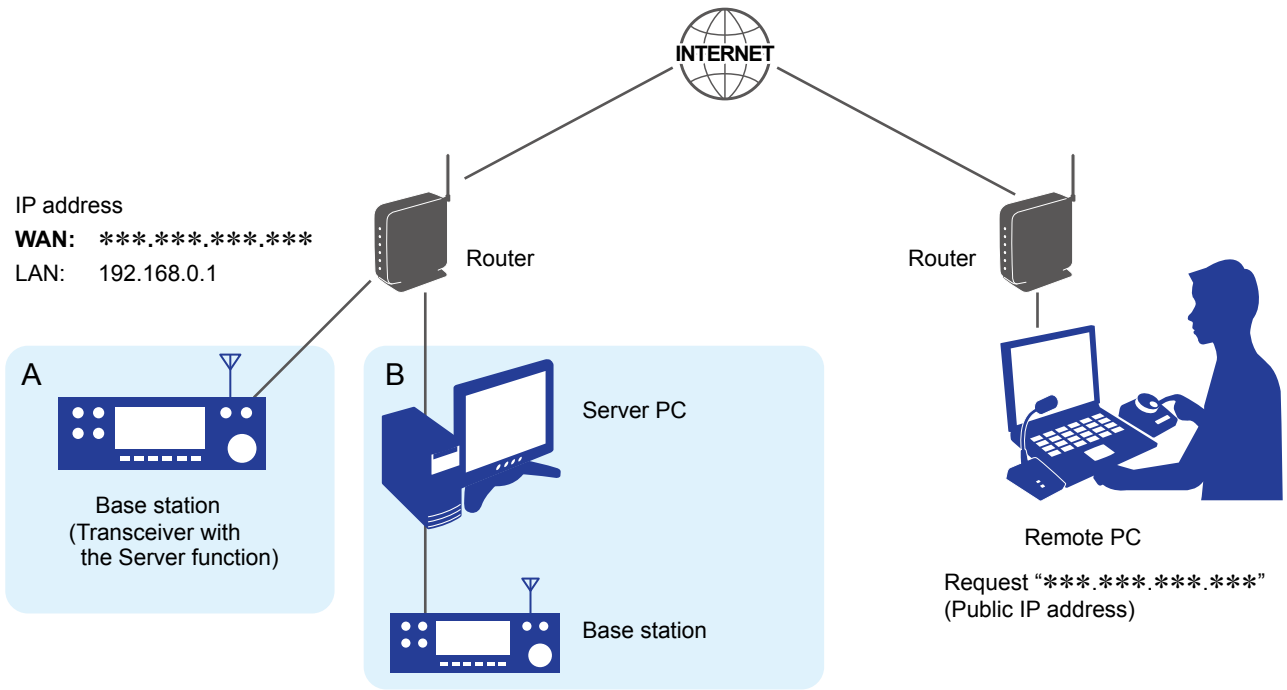

4 CONFIGURING THE SYSTEM THROUGH THE INTERNET

About a public IP address and the Dynamic DNS service

◇ To let PCs connect to the Base station using its domain name

If you set up an account for a Dynamic DNS server, the DNS server resolves the domain name into your dynamic IP address. Using the domain name, PCs can connect to the Base station through the Internet, even if the Base station's public IP address is changed.

① Check the router's manual about how to configure your router to use the Dynamic DNS services.

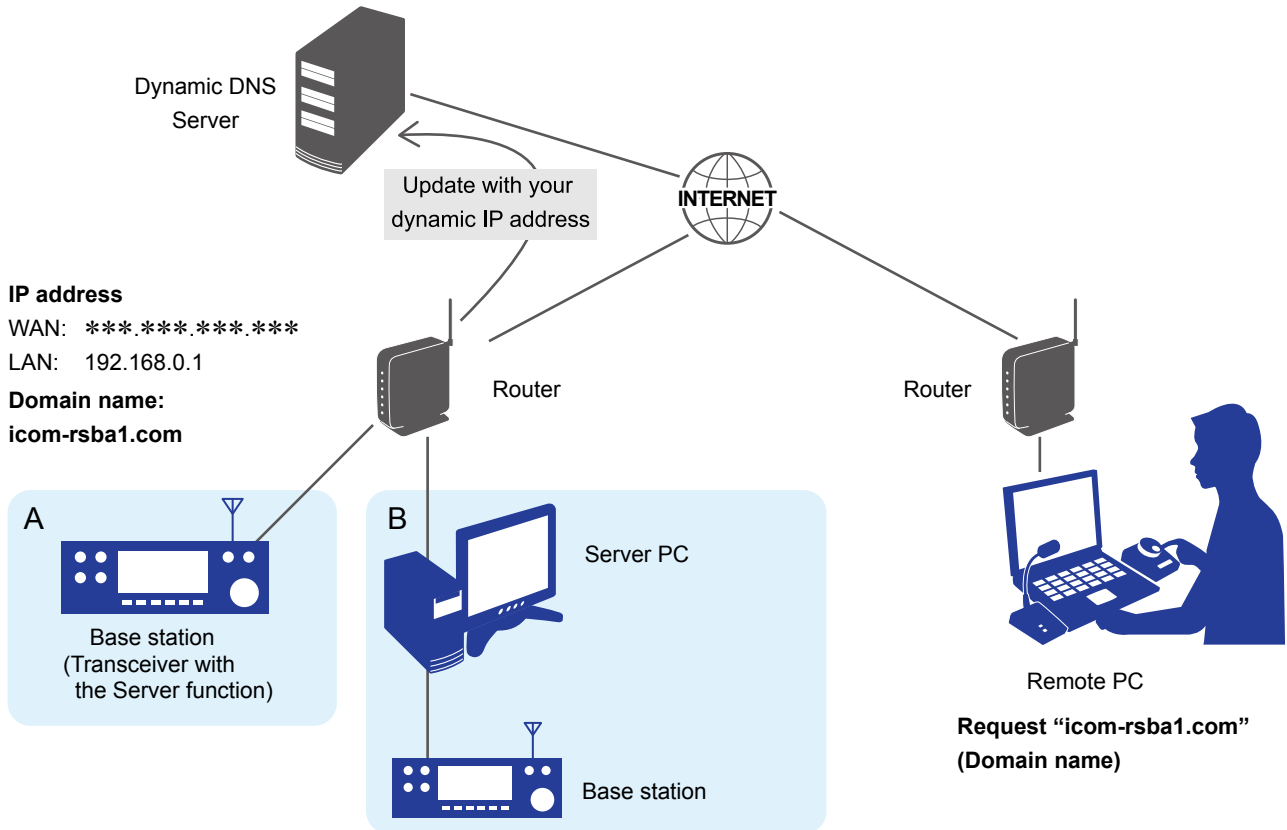

Port forwarding

If you configure the remote control system through the Internet, you need to configure your router to enable connections from the Internet.

To enable connections, forward the port used with the Remote Utility.

NOTE: Icom is not responsible for any accidents caused by the security degradation after this port forwarding.

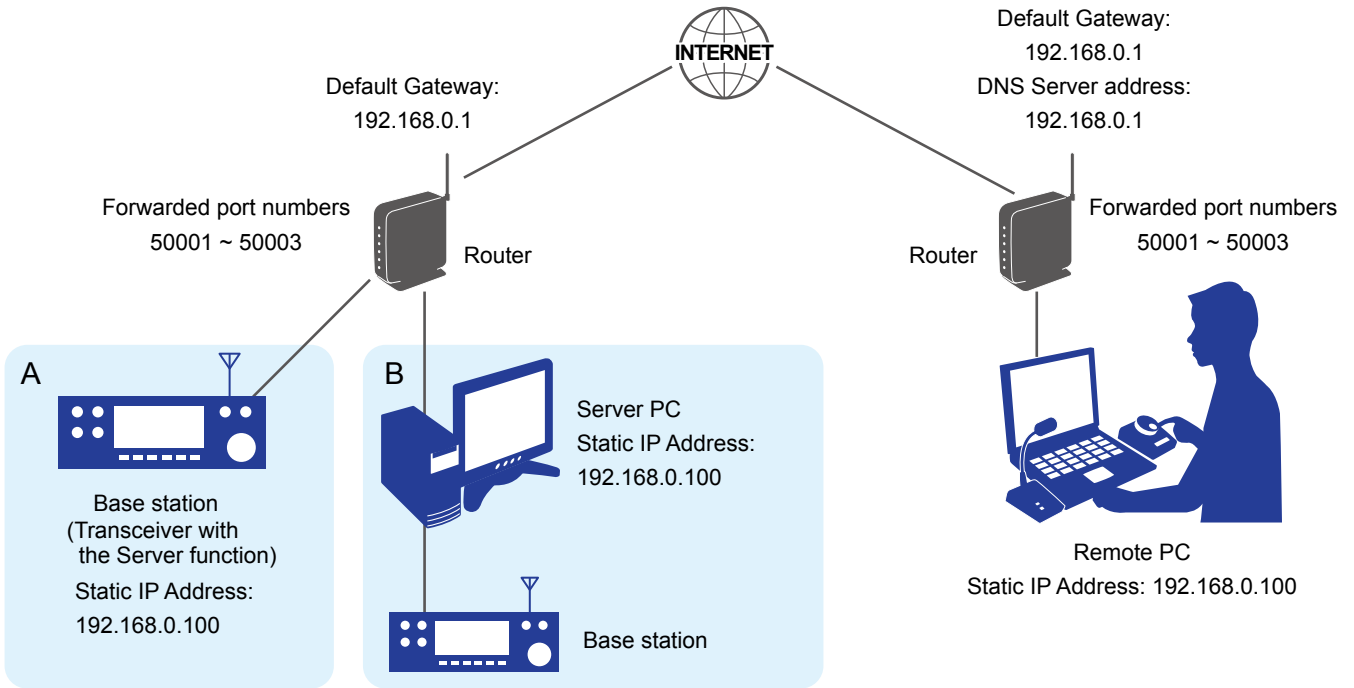

1 Set the static local IP address to the Base station or Server PC.

Set a static local IP address to the Base station or Server PC.

Information

- Usable IP addresses differ, depending on your router. Check the router’s manual for details.
- **DO NOT** set the same IP address to 2 or more devices that are connected to the same router.
- Check your PC’s manual about the setting details.

Transceiver setting

Items	Contents
DHCP	ON (Default) → OFF
IP Address	An IP address that is not assigned to any other device. Example: 192.168.0.10 (Default)
Default Gateway	An IP address of the LAN side on the router Example: 192.168.0.1
Control Port (UDP)	50001 (Default)
Serial Port (UDP)	50002 (Default)
Audio Port (UDP)	50003 (Default)

2 Forward the port.

- Forward port numbers that are used for the RS-BA1. (Default: 50001 ~ 50003)
- “UDP” should be used as the port protocol.
- Set a static local IP address in step 1 as a destination port.
- ① Check the router’s manual about how to forward ports.
- ① Depending on the router settings, you must configure the IP filter settings. Check the router’s manual how to configure the settings.

STEP 1. Settings on the Base station

◇ A. When using a transceiver with the Server function

Set each setting item on the Base station transceiver.

NOTE: When you change a setting that displays “(Valid after Restart),” you must restart the transceiver after setting. After restarting, keep the transceiver’s power ON or remain in the remote standby mode.

Network setting

Items	Contents
Network Control	OFF (Default) → ON
Internet Access Line	Your Internet access line type Example: FTTH (Default)

User registration

Items	Contents
Network User1/2/3* ID	A User ID ① Up to 16 characters Example: USER1
Network User1/2/3* Password	A Password ① 8 ~ 16 characters ① At least 2 different characters must be used. Example: USER0001
Network User1/2/3* Administrator	NO (Default) → YES ① When the user is set as an administrator.

* There is no User3 in the IC-7610.

NOTE: To prevent unauthorized access

Set a long and strong password so that no one can possibly guess it. Mix upper and lower case letters, numbers or characters. Periodically changing the password is recommended.

4 CONFIGURING THE SYSTEM THROUGH THE INTERNET

STEP 1. Settings on the Base station

◇ A. When using a transceiver with the Server function (Continued)

Transceiver registration

Items	Contents
Network Radio Name	A Network Radio Name ① Up to 16 characters Example: IC-7851abc

Transmit audio setting (For the IC-7800 and IC-7700)

Items	Contents
Network MOD Use	ON (Default)

TIP: Standby mode setting

To remotely control the transceiver using the RS-BA1, the transceiver should be turned ON or be in the standby mode.

To set the transceiver in the standby mode, set the item described below and select “Standby (for Remote Control)” on the displayed screen when you turn OFF the transceiver.

① The LED above [POWER] slowly blinks orange if the transceiver is in the standby mode.

Items	Contents
Power OFF Setting (for Remote Control)	Standby/Shutdown

NOTE: Before “STEP 2. Settings on the Remote PC’s Remote Utility application” (p. 4-11)

Confirm the settings described below.

- Public IP address or Domain name (p. 4-2)
- Base station’s Network User ID and Password

① Keep the transceiver’s power ON, or remain in the Remote Standby mode

4 CONFIGURING THE SYSTEM THROUGH THE INTERNET

STEP 1. Settings on the Base station

◇ B. When using the Server PC

Connect the transceiver to the Server PC and setup the Remote Utility.

- 1 Connect the transceiver to the Server PC.**
Connect the transceiver to the Server PC with a cable.
① See page 2-2 about the connection.

- 2 Open the Remote Utility.**
 1. Open "Icom Remote Utility."
 2. "Set your own PC information." is displayed, then click <OK>.
① When you first open the Remote Utility, this screen is displayed.

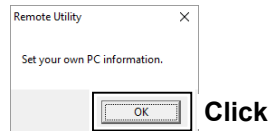

- 3 Configure the settings.**
 - ① When you first open the Remote Utility, this screen is displayed.
 1. Enter a name for your PC of up to 16 characters. (Example: Server PC)
① **DO NOT** use the same name for more than one PC on your network.
 2. Confirm the port numbers of the Control, Serial and Audio ports.
① You should use the default port numbers for these ports.
 3. Select your internet access line type.
 4. Select the software display language.
① The selected language will be used as the Help file language.
 5. Click <Register> to save the settings.
 6. Click <OK>, and then restart the Remote Utility.

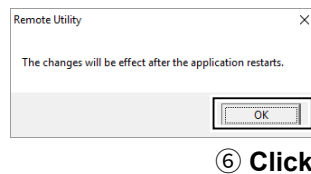
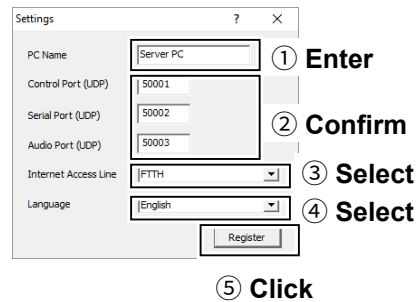

- 4 Click the Setup that you want to do.**
 - ① If no Servers and no radios are registered, this screen is displayed.
Click "Setup for a Server PC (The radio is accessible by Remote PC(s))."

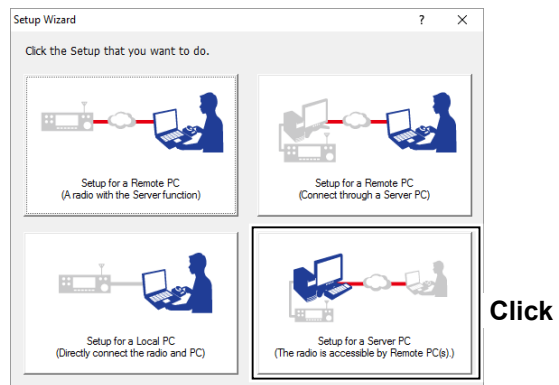

- 5 Start the Setup Wizard.**
Click <Next>.

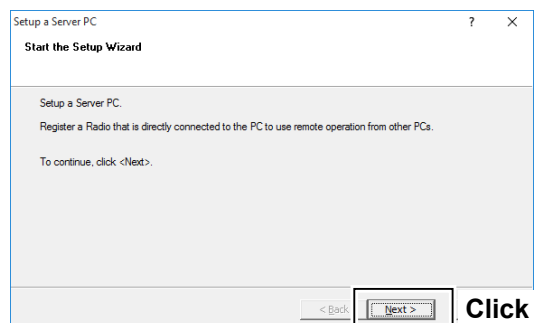

4 CONFIGURING THE SYSTEM THROUGH THE INTERNET

STEP 1. Settings on the Base station

◇ B. When using the Server PC (Continued)

- 6 Select a Radio for the Remote operation.**
1. Select a transceiver that you want to add.
 - ① If the transceiver has already been registered, select “Registered radios” and select it from the drop-down list.
 2. Click <Next>>.

The screenshot shows a dialog box titled "Register a Radio" with a close button (X) and a help button (?). The main heading is "Select a Radio for Remote operation" with the instruction "Select a Radio that is accessible from other PCs." Below this, there is a text area: "Select [new] if you want to register a new radio that is accessible from other PCs. Or select from [Registered radios]. After selecting, click <Next>." There are two radio buttons: "New" (selected) and "Registered radios" (with a dropdown menu labeled "Select a radio"). At the bottom, there are "< Back" and "Next >" buttons. A red box highlights the "Next >" button with the label "Click".

- 7 Selecting a Radio**
- ① If you select “Registered radios” in step 6, go to the next page (step 9).
1. Select a connection type (Example: USB).
 - ① If the transceivers are not listed, click <Search>.
 - ① Select “Manual” if the transceiver is connected to the PC using other than a USB cable. Select the connected transceiver from the drop-down list.
 2. Click <Next>>.

The screenshot shows a dialog box titled "Register a Radio" with a close button (X) and a help button (?). The main heading is "Selecting a Radio" with the instruction "Select a Radio that you want to add." Below this, there is explanatory text: "If the radio is connected to the PC using a USB cable, select the radio from the [USB] drop-down list. Then click <Next>. If the radio is not listed, confirm the radio is ON and the cable is firmly connected. Wait for a while until the PC recognizes the device, and then click the <Search> button." and "If the radio is connected to the PC using other than a USB cable, select from the radio from the [Manual] drop-down list. Then click <Next>." There are two radio buttons: "USB" (selected) and "Manual" (with a dropdown menu labeled "Other"). The "USB" section has a dropdown menu showing "IC-7300" and "COM=3", and a "Search" button. A red box highlights the "Other" dropdown menu with the label "1 Select". At the bottom, there are "< Back" and "Next >" buttons. A red box highlights the "Next >" button with the label "2 Click".

- 8 Set the CI-V/COM port settings.**
- ① If you select “Registered radios” in step 6, go to the next page (step 9).
1. Set the CI-V address, Baud Rate, and COM Port Number.
 - ① If you select “USB” in step 5, there are no necessary changes.
 2. Click <Next>>.

The screenshot shows a dialog box titled "Register a Radio" with a close button (X) and a help button (?). The main heading is "CI-V/COM port Settings" with the instruction "Set the IC-7300's CI-V settings." Below this, there is explanatory text: "If you want to change the CI-V address and/or Baud rate, change from the lists below. The Radio has the Spectrum scope function. If you use the function on the Remote Controller, the USB Baud rate must be set to 115200 bps. At this time, also confirm the setting of the CI-V USB Port item is 'Unlink to [REMOTE]'." and "The COM port number is automatically set. If they are no necessary changes, click <Next>." There are three input fields: "Address" (set to "94"), "Baud Rate" (set to "115200"), and "COM Port Number" (set to "COM3"). A red box highlights the "COM Port Number" dropdown menu with the label "1 Set". At the bottom, there are "< Back" and "Next >" buttons. A red box highlights the "Next >" button with the label "2 Click".

4 CONFIGURING THE SYSTEM THROUGH THE INTERNET

STEP 1. Settings on the Base station

◇ B. When using the Server PC (Continued)

When you select “Manual” in step 7:

The Audio Settings screen is displayed. Select the devices that input a received audio from the transceiver and output a modulation to the transceiver, and then click <Next>.

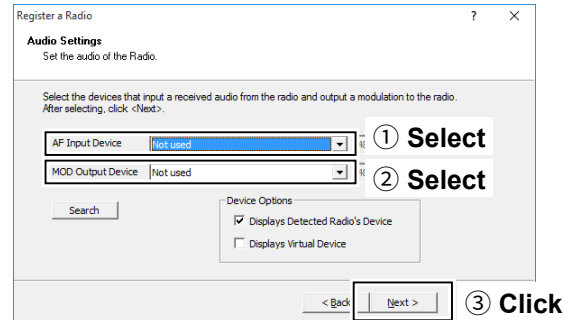

9 Register a User to allow a connection.

1. Click <Add>.
 - The Add User screen is displayed.
2. Enter a User ID. (Example: USER1)
3. Enter a password of more than 8 characters. (Example: USER0001)
4. Click <OK>.
5. Select a registered user.
6. Click <Add >>>.
7. Click <Next >>.

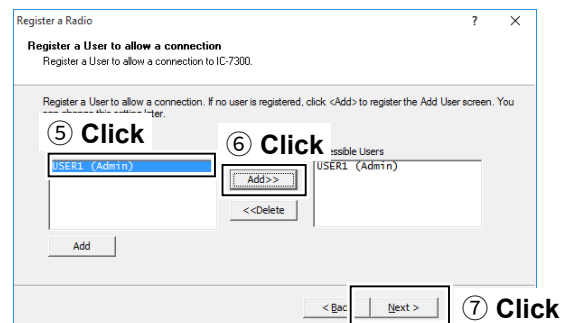
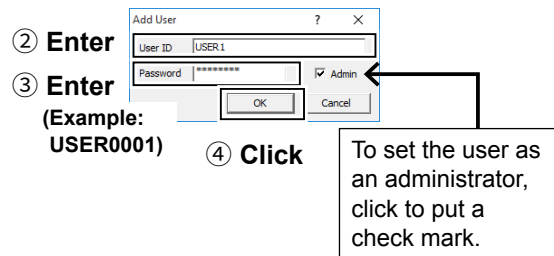
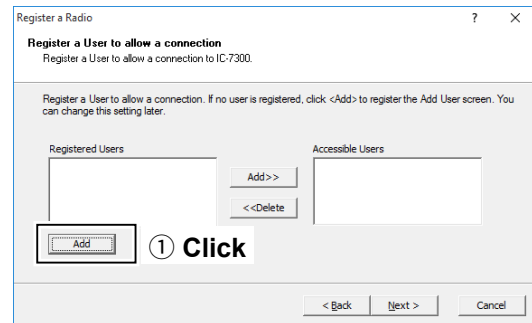

NOTE: To prevent unauthorized access

Set a long and strong password so that no one can possibly guess it. Mix upper and lower case letters, numbers or characters. Periodically changing the password is recommended.

4 CONFIGURING THE SYSTEM THROUGH THE INTERNET

STEP 1. Settings on the Base station

◇ B. When using the Server PC (Continued)

10 Enter the radio name.

1. Enter the radio name.
① The radio's model name and the last 5 digits of the serial number is entered by default.
2. Click <Next>>.

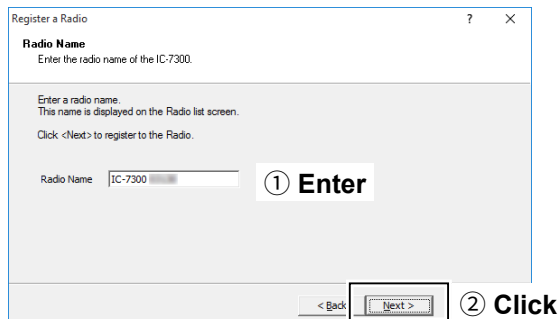

11 The registration of the Radio is completed. Click <Finish>.

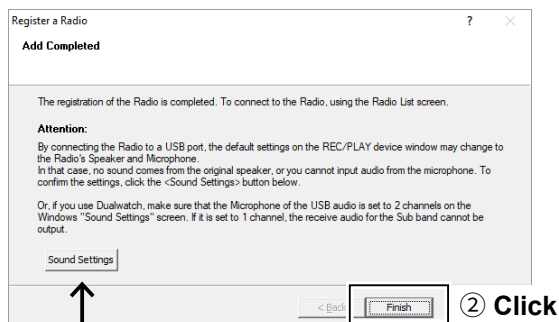

By connecting the transceiver to a USB port, the default settings on the REC/PLAY device window may change to the Radio's Speaker and Microphone. To confirm the settings, click <Sound Settings>.

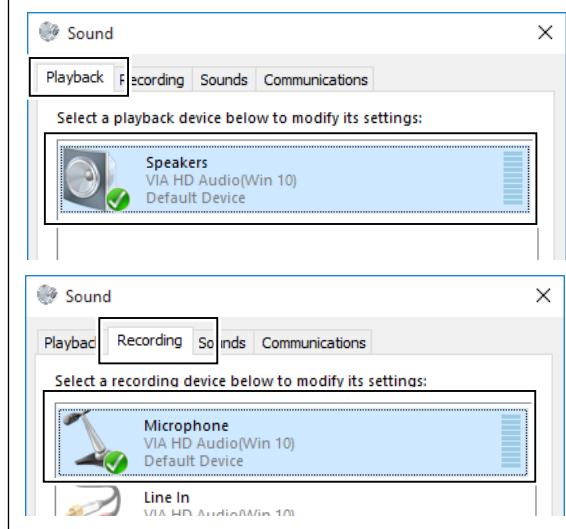

NOTE: Before "STEP 2. Settings on the Remote PC's Remote Utility application" (p. 4-11)

Confirm the settings described below.

- Public IP address or Domain name
- Base station's Network User ID and Password

① Keep the transceiver's power ON, or remain in the Remote Standby mode

STEP 2. Settings on the Remote PC's Remote Utility application

This section describes how to setup the Remote PC.

① Before configuring the settings, connect a speaker and microphone or headset to the PC.

1 Open the Remote Utility.

1. Open "Icom Remote Utility."
2. "Set your own PC information." is displayed, then click <OK>.
 - ① When you first open the Remote Utility, this screen is displayed.

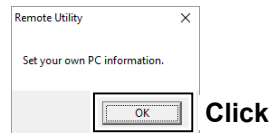

2 Configure the settings.

- ① When you first open the Remote Utility, this screen is displayed.
 1. Enter a name for your PC of up to 16 characters. (Example: User PC)
 - ① **DO NOT** use the same name for more than one PC on your network.
 2. Confirm the port numbers of the Control, Serial and Audio ports.
 - ① You should use the default port numbers for these ports.
 3. Select your Internet access line type.
 4. Select the software display language.
 - ① The selected language will be used as the Help file language.
 5. Click <Register> to save the settings.
 6. Click <OK>, and then restart the Remote Utility.

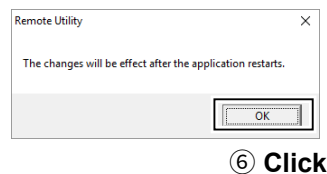
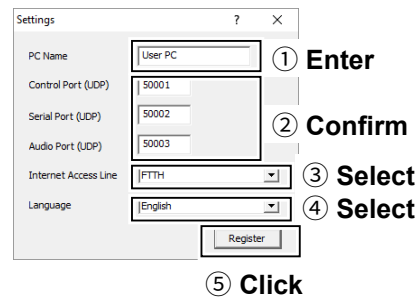

3 Click the Setup that you want to do.

- ① If no servers nor no radios are registered, this screen is displayed.

Click "Setup for a Remote PC (A radio with the Server function)" or "Setup for a Remote PC (Connect through a Server PC)."

 - ① Example: "Setup for a Remote PC (A radio with the Server function)"

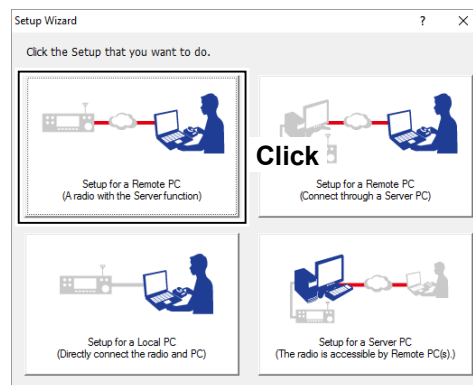

4 Start the Setup Wizard.

Click <Next>.

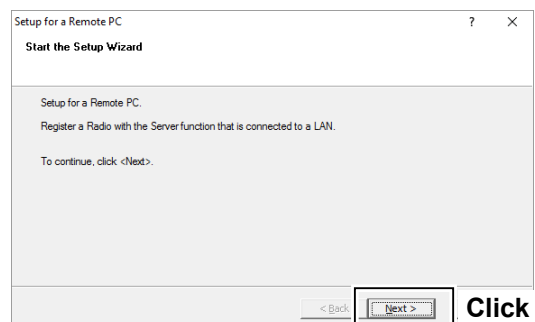

4 CONFIGURING THE SYSTEM THROUGH THE INTERNET

STEP 2. Settings on the Remote PC's Remote Utility application

5 Enter the Server Information.

1. Enter the Base station's domain name or public IP Address.
① You should use the default port number for this port.
2. Confirm the Control Port number.
3. Click <Next>>.

Server Address or Network Name: icom-rsba1.com

Control Port (UDP): 50001

① Enter

② Confirm

< Back Next > ③ Click

6 Enter the User ID and Password.

1. Enter the User ID and Password that are registered to the transceiver.
2. Click <Next>>.
 - After clicking <Next>>, connects to the server.

User ID: USER1

Password: *****

① Enter

② Enter (Example: USER0001)

< Back Next > ③ Click

TIP: If you cannot connect to the server, an error dialog is displayed.
Click <<Back>, and confirm the settings.

The Server Connection failed

The Server is not found. Cannot connect to the Server.
Click: <Back> and confirm the Server address or Network name.
Or click: <Next> to save the Server.

< Back Next > Cancel

7 Adding the Server has been completed.

1. Enter the Server Description.
① The Server Address or Network Name is entered by default.
2. Click <Finish>.

Server Description: icom-rsba1.com

① Enter

The following radios that are registered to the Server are added to the Radio List.
To connect to the radio, using the Radio List screen.
-IC-7851abc

< Back Finish ② Click

4 CONFIGURING THE SYSTEM THROUGH THE INTERNET

STEP 2. Settings on the Remote PC's Remote Utility application

8 Configure the settings to connect to the Base station.

1. Select the transceiver.
2. Click <Settings>.
3. Click <Recommended>.
 - The Select Network screen is displayed.
4. Select **Internet**.
5. Click <Next>.
 - The recommended values for your network are displayed.
6. Click <Yes> to automatically set the displayed values in each field of the Network Setting, then close the Select Network screen.
7. Select a virtual COM port number.
 - ① The selected COM port number is used for CI-V operation with the transceiver.
 - ① When you connect to the transceiver with the Remote controller, you have to set the COM port number.
8. Select an audio device in **Speaker** that your speaker is connected, to output the received audio from the network.
9. Select an audio device in **Mic** that your microphone is connected, to transmit the input audio to the network.
10. Click <OK>.

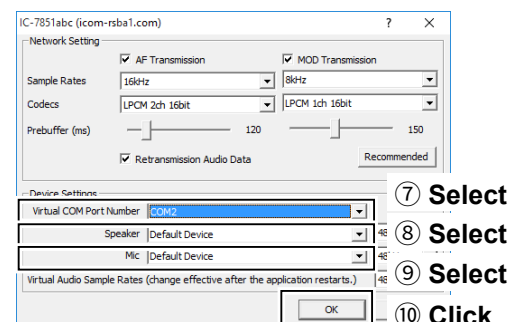
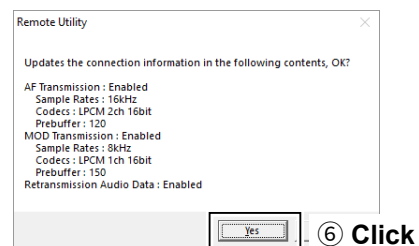
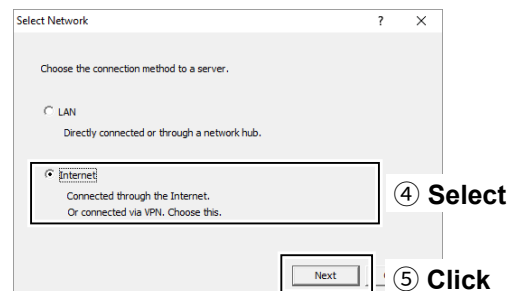
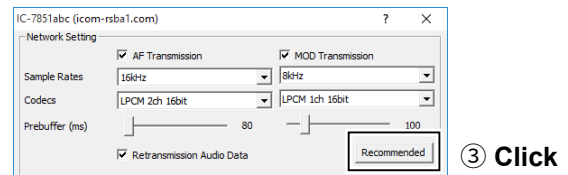
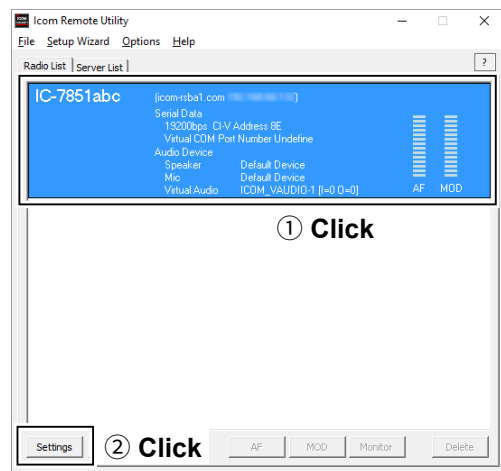

4 CONFIGURING THE SYSTEM THROUGH THE INTERNET

STEP 2. Settings on the Remote PC's Remote Utility application

9 Connect the transceiver.

1. Click <Connect>.
 - The dialog that indicates the virtual serial port is displayed.
 - ① If the connection fails, and an error screen is displayed, solve the problem. (p. 7-2)
2. Click <OK>.
 - “<<Connected>>” is displayed under the radio name when the connection has succeeded.

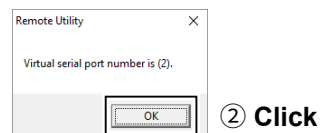
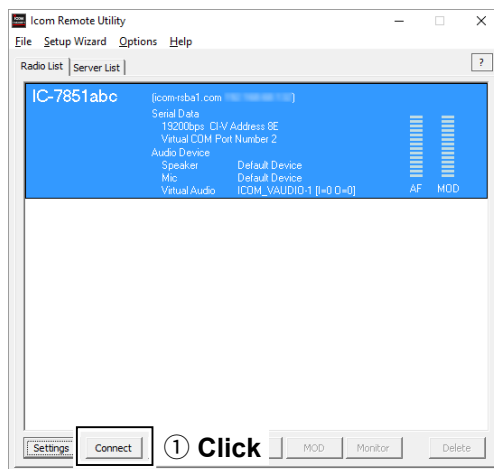



STEP 3. Starting the Remote control operation

This section describes how to connect and start remotely controlling a transceiver from a Remote PC using the Remote Controller.

The description in this section is based on the assumption that the connection to the transceiver using the Remote Utility has succeeded. (“<<Connected>>” is displayed under the radio name.)

1 Connect setting using the Remote Controller application

1. Open “RS-BA1 Remote Control Version 2.”
2. Click  in the toolbar, or click “Connect Setting...” in the Option menu.
 - The Connect Setting screen is displayed.
 - ① You cannot change the settings while the transceiver is connected to the Remote Controller.
3. Select a transceiver to access using the Remote Utility application, in **Model**.
(Example: IC-7851 (Ver1.30 -) (DUAL))
4. Select the connection between the transceiver and PC in **Connection**. (Example: LAN)
 - ① When the “MOD Select has also been changed.” dialog is displayed, click <OK>.
 - ① The confirmation dialog for the connection setting may be displayed, depending on the transceiver. If connected correctly, click <OK>.
5. Select a transceiver to access using the Remote Utility application, in **Remote Utility**.
(Example: IC-7851abc)
 - The CI-V settings are automatically loaded from the Remote Utility application to **CI-V**. The settings include the virtual COM Port number, transceiver’s CI-V address, and baud rate.
 - ① If the desired transceiver is not displayed in **Remote Utility**, click <Search> to load the transceiver’s information from the Remote Utility application.
6. Check “**Software closing turns OFF the Radio.**” to turn OFF the transceiver when the Remote Controller application is closed by clicking  or “Exit” on the File menu.
 - ① When you shut down the PC while the Remote Controller application is still running, the transceiver may not be turned OFF.
 - ① For other settings, see the Remote Controller’s Help file.
7. Click <OK> to save the settings and close the screen.

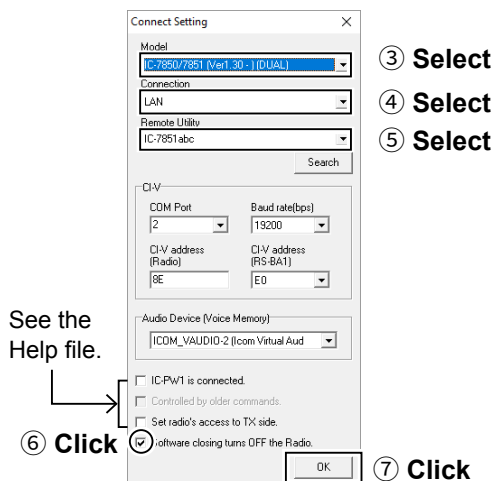

4 CONFIGURING THE SYSTEM THROUGH THE INTERNET

STEP 3. Starting the Remote control operation

2 Connecting to the transceiver using the Remote Controller application

- Click <  > in the toolbar, or click “Connect ON” in the File menu.
- When the connection has succeeded, the transceiver’s current data will be displayed on the main panel.

3 Selecting a modulation input connector

To transmit audio when remotely controlling the transceiver from the Remote Controller, configure the following settings, depending on the transceiver’s connector.

1. Click <MIC SET> on the Remote Controller.
 - The MIC SET screen is displayed.
2. Select an appropriate connector in **MOD Select (Remote ON)** (Example: LAN), to input transmit audio from the PC to the transceiver.
3. Click the close button to close the screen.

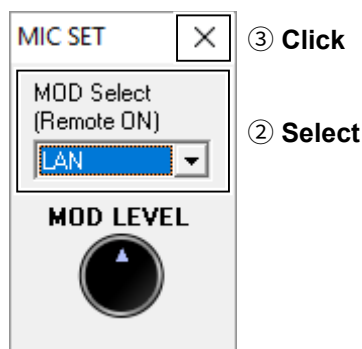

4 Remote control operation

See the RS-BA1 Remote Controller’s Help file for remote operation details, such as how to change the frequency or how to turn ON each function.

To display the Help file, click “Contents” in the Help menu on the Remote Controller application, or push the [F1] key on your PC’s keyboard.

NOTE:

- **DO NOT** allow the PC to go into the sleep or standby mode while using the RS-BA1. Otherwise, it might not work properly after the PC resumes normal activity.
- **When not using the transceiver:**
Follow the steps below to finish the remote control operation.
 1. Disconnect the transceiver from the Remote Controller application, and then close the Remote Controller application.
 2. Disconnect the transceiver from the Remote Utility application, and then close the Remote Utility application.
 3. Turn OFF the transceiver and the PC.
 - ① If you check **Software closing turns OFF the Radio.**, when you close the Remote Controller, the transceiver is also turned OFF.
- When you manually select the transmit audio input connectors to be used after finishing the remote control operation, right-click  in the toolbar, or click “Remote Setting...” in the File menu to select.
 - ① Regularly, it automatically returns to the original setting before you start the remote control operation.

TIP: Importing the repeater list

You can easily set the DV mode repeater information by importing the repeater list preset for each transceiver. See the RS-BA1 Remote Controller’s Help file for importing details.

Setting your PC's environment

Configure your PC's environment in the Remote Utility.
The settings will take effect after rebooting the Remote Utility.

- ① When you first open the Remote Utility, the Settings screen is displayed.
After configuring the settings, you can display other setting screens.

1. Click "Options."
2. Click "Settings."
- The "Settings" screen is displayed.
3. Configure the settings.
4. Click <OK> to save the settings.
- "The changes will be effect after the application restarts." is displayed.
5. Click <OK>.
- ① The settings will take effect after restarting the Remote Utility.

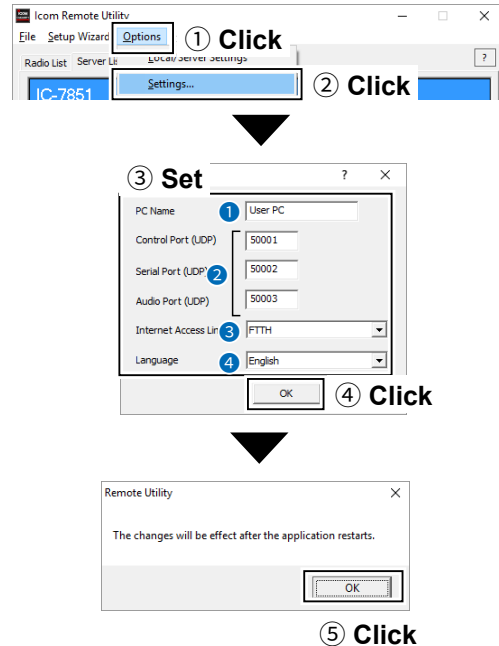

① PC Name

Enter a name for your PC of up to 16 characters.
① **DO NOT** use the same name for more than one PC on your network.

② Port numbers

Enter the port numbers of the Control, Serial, and Audio ports.
You should use the default port numbers for these ports.

③ Internet Access Line

Select your internet access line type.

④ Language

Select the software display language.
The selected language will be used as the Help file language.

NOTE: If you configure the remote control system through the Internet, and change the port number of the Control, Serial or Audio port, you should reconfigure the port forwarding settings and the IP filter settings on your router. (p. 4-4)

Transceiver Registration

In the Remote Utility, register the transceivers that are physically connected to your PC. See p. 2-2 to connect a transceiver to your PC.

◆ Adding a transceiver

1. Click “Options.”
2. Click “Local/Server Settings.”
3. Click <Add>.
 - The “Purpose of use” screen is displayed.
4. Select an option, and then click <Next >>.
 - ① If you select “Only accessible from this PC,” the registered transceiver cannot be operated from other PCs. If you want to operate the Base station transceiver from other PCs, select “Accessible from other PCs.”
5. Set the transceiver information according to the displayed screen.
 - ① See pages 2-7, 3-4, or 4-7 about the settings.

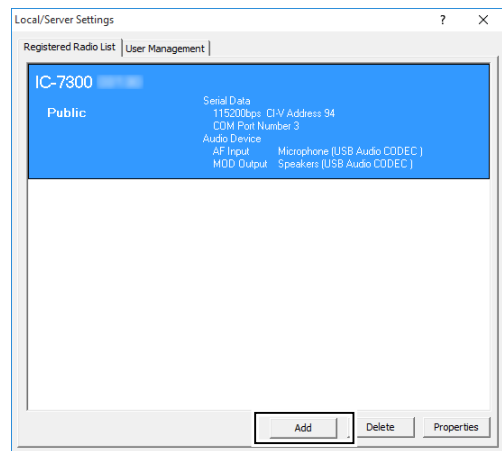
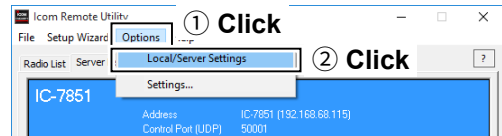

③ Click

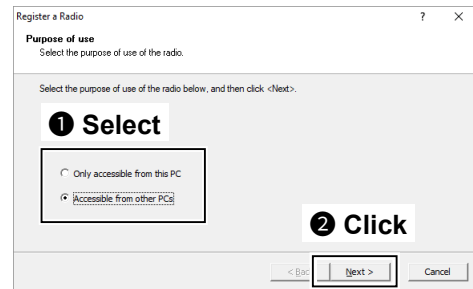

TIP: When you add a transceiver from the Setup Wizard screen, click “Setup for a Server PC (The radio is accessible by Remote PC(s).)” or “Setup for a Local PC (Directly connect the radio and PC).”

① To display the Setup Wizard screen, click “Setup Wizard” on the top menu.

5 ABOUT THE REMOTE UTILITY

Transceiver Registration

◇ Changing a transceiver's properties

1. Click "Options."
2. Click "Local/Server Settings."
3. Select a transceiver.
4. Click <Properties>.
5. Change the settings, and then click <OK>.

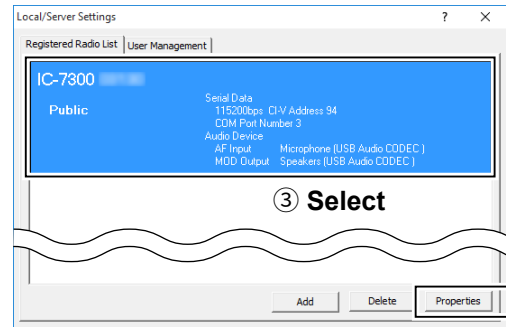
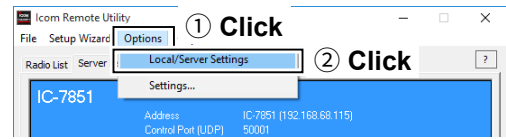

④ Click

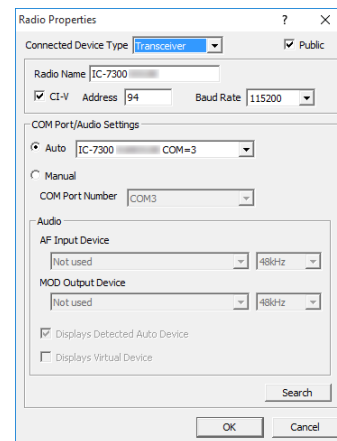

◇ Deleting a transceiver

1. Click "Options."
2. Click "Local/Server Settings."
3. Select a transceiver.
4. Click <Delete>.

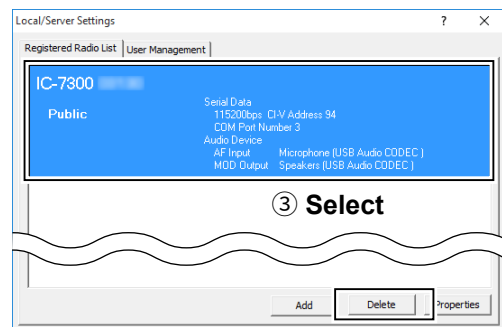
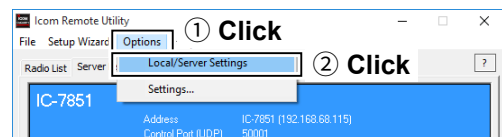

④ Click

5 ABOUT THE REMOTE UTILITY

Transceiver Registration

◇ Adding a user who can access the transceiver

1. Click "Options."
2. Click "Local/Server Settings."
3. Click the <User Management> tab.

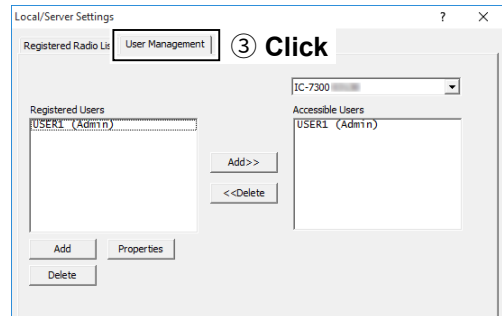
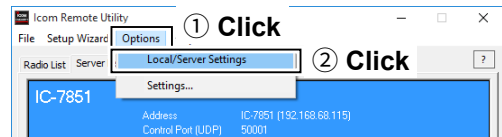

Adding a user

1. Click <Add>.
2. Enter a user ID of up to 16 characters, case sensitive.
① You cannot register an already registered ID.
3. Enter a password, of 8 ~ 16 characters, case sensitive.
① At least 2 different characters must be used.
4. Click <OK>.

To prevent unauthorized access:

Set a long and strong password so that no one can possibly guess it. Mix upper and lower case letters, numbers or characters. Periodically changing the password is recommended.

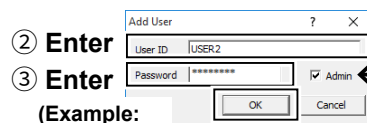
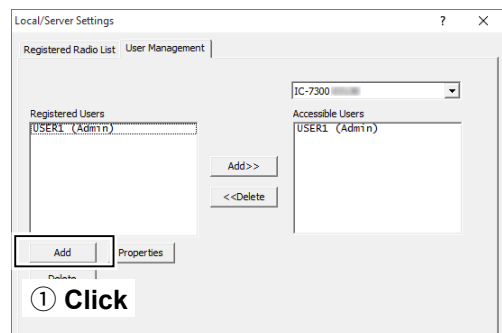

(Example:
USER002)

To set the user as an administrator, click to put a check mark.

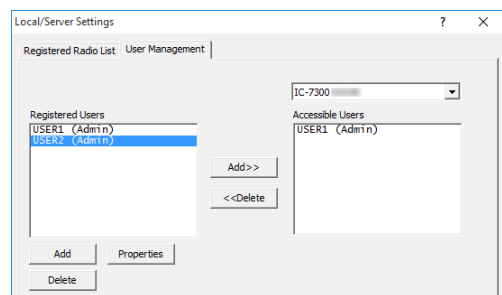

5 ABOUT THE REMOTE UTILITY

Transceiver Registration

◇ Adding a user who can access the transceiver (Continued)

To allow a user to use a transceiver

1. Select a transceiver that you allow the user to use.
2. Select the user.
3. Click <Add>>.

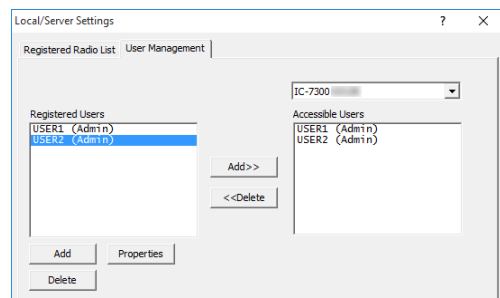
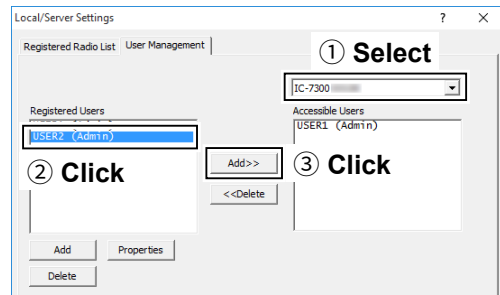

To inhibit a user to use a transceiver

1. Select a transceiver that you inhibit the user to use.
2. Select the user.
3. Click <<<Delete>.

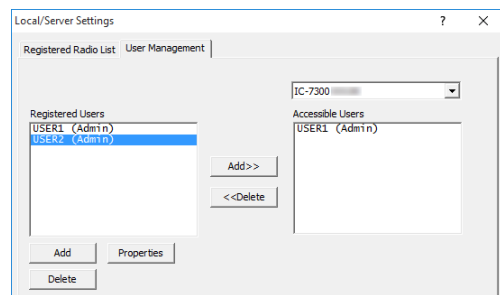
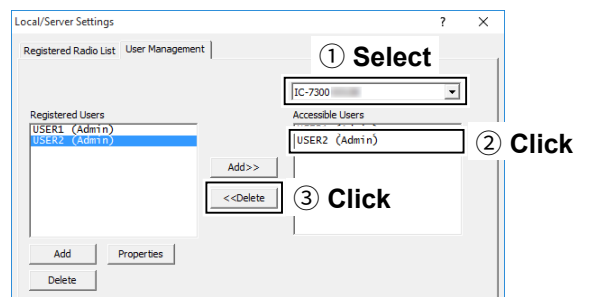

5 ABOUT THE REMOTE UTILITY

Transceiver Registration

To change a user properties

1. Select a user.
2. Click <Properties>.
3. Change the settings, and then click <OK>.

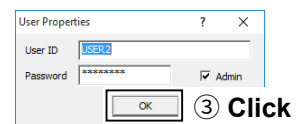
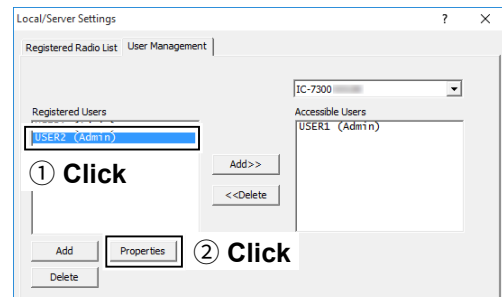

To delete a user

1. Select a user.
2. Click <Delete>.

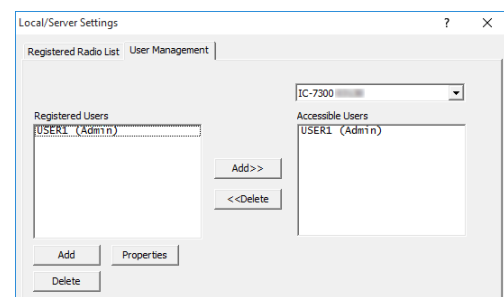
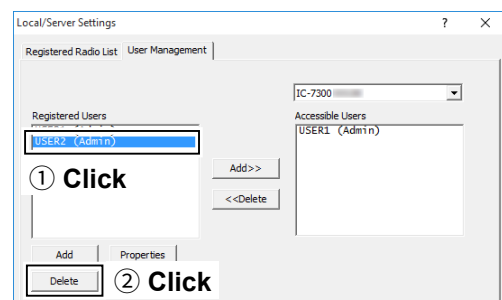

Server Registration

To connect to a Base station transceiver through the network, Remote PCs should first connect to a Server using the Remote Utility. Before connecting, enter the Server information.

◇ Adding a Server

1. Click <Server List>.
 2. Click <Add>.
 - Set the Server information according to the displayed screen.
- ① When connecting to a Base station transceiver through a LAN, see page 3-10 about the settings. When connecting to a Base station transceiver through the Internet, see page 4-11.

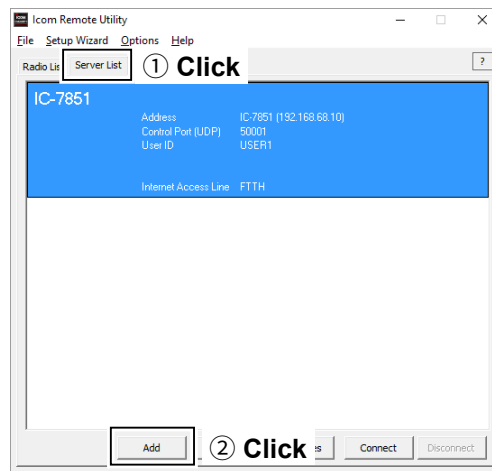

TIP: When you add a server from the Setup Wizard screen, click “Setup for a Remote PC (A radio with the Server function)” or “Setup for a Remote PC (Connect through a Server PC).”

① To display the Setup Wizard screen, click “Setup Wizard” on the top menu.

5 ABOUT THE REMOTE UTILITY

Server Registration

◇ Changing a server's properties

1. Click <Server List>.
2. Select a server.
3. Click <Properties>.
4. Change the settings, and then click <OK>.

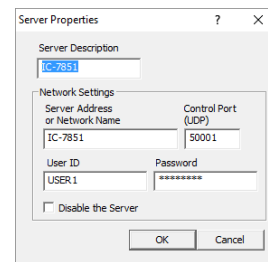
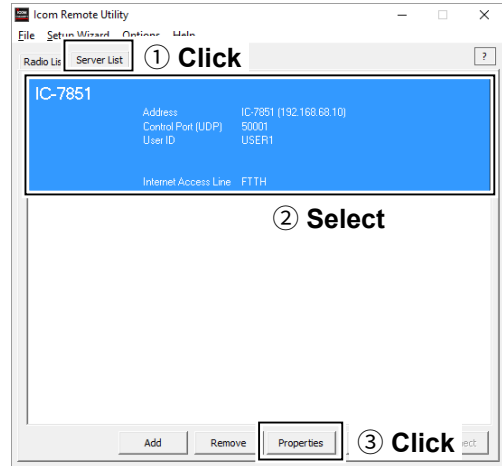

◇ Deleting a server

1. Click <Server List>.
2. Select a server.
3. Click <Remove>.

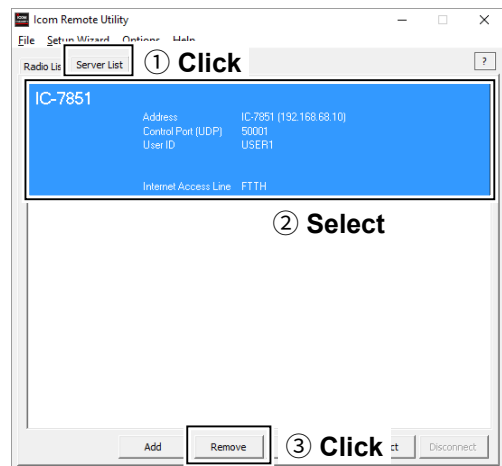

Connecting to a Server

◇ Connecting to a Server

1. Click <Server List>.
2. Select a server.
3. Click <Connect>.
4. “Connected” is displayed under the Server name when the connection has succeeded.
 - ① If the connection fails, and an error screen is displayed, solve the problem. (p. 7-1)

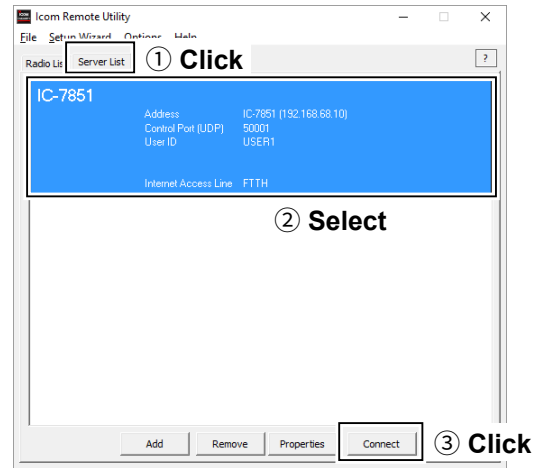

◇ Disconnecting from a Server

1. Click the <Server List> tab.
2. Select the connected server.
3. Click <Disconnect>.

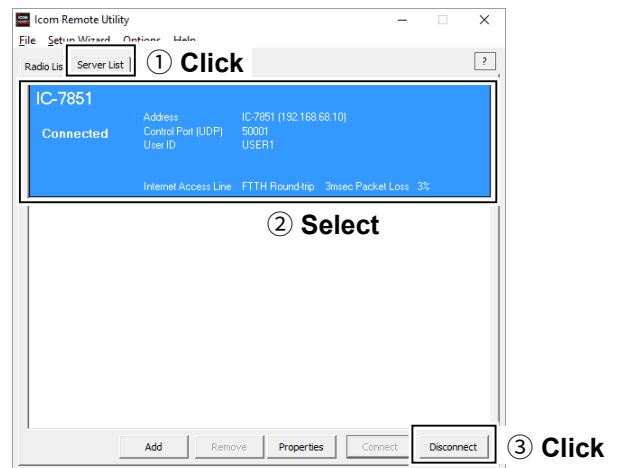

Connection setting

When the connection to the Server has succeeded, the Base station transceivers are displayed on the Radio List screen. Select a transceiver from the list, then connect it to the network using the Remote Utility.

You have to configure the network audio quality and devices to connect.

① To control the transceiver, connect to the transceiver using the Control software.

TIP: If the connection setting is finished, you can simply connect to the transceiver by selecting it on the Radio List screen and then clicking <Connect>.

1. Click <Radio List>.
 2. Select a transceiver.
 3. Click <Settings>.
- ① For the transceivers that are “<<Connected>>” or “Offline,” the Connection Setting cannot be changed.

NOTE: When using the DUAL mode screen in the Remote Controller, set the codec setting for “AF Transmission” to 2 channels.

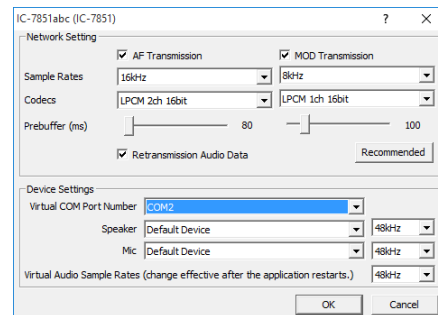
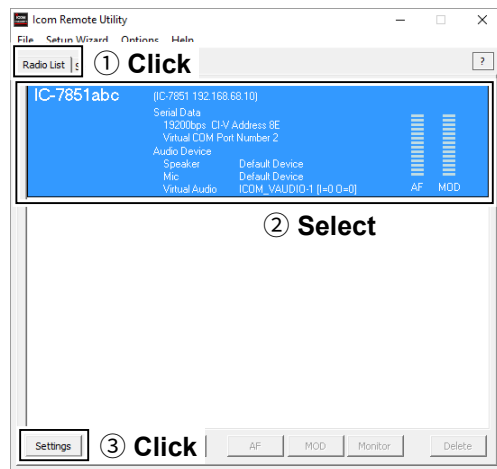

Connecting to a transceiver

If the connection setting is finished, you can simply connect to the transceiver by selecting it on the Radio List screen and then clicking <Connect>.

◇ Connecting to a transceiver

1. Click <Radio List>.
2. Select a transceiver.
3. Click <Connect>.
4. Click <OK>.
 - “<<Connected>>” is displayed under the radio name when the connection has succeeded.
 - ① If the connection fails, and an error screen is displayed, solve the problem. (p. 7-2)

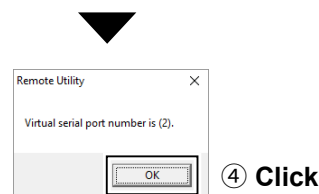
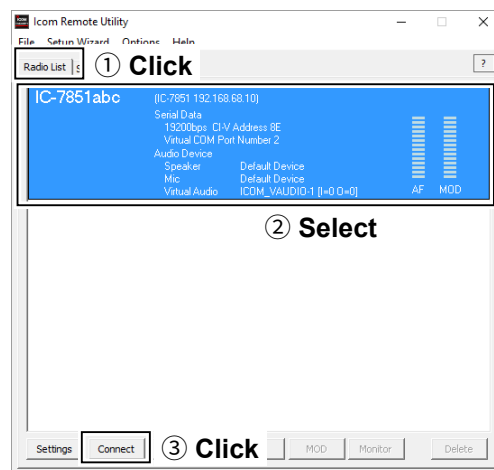

◇ Disconnecting a transceiver

1. Click <Radio List>.
2. Select a transceiver with “<<Connected>>” under its name.
3. Click <Disconnect>.
 - “Do you want to disconnect the radio?” is displayed.
4. Click <Yes> to disconnect the transceiver.

NOTE:

- Be sure to disconnect when not using the transceiver. Otherwise, other users cannot connect to it.
- The administrators can terminate a connection between another user and a transceiver. If “<<Connected>>” disappears while connecting to a transceiver, the administrator may terminate the connection.

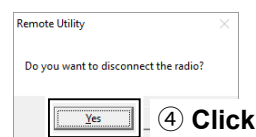
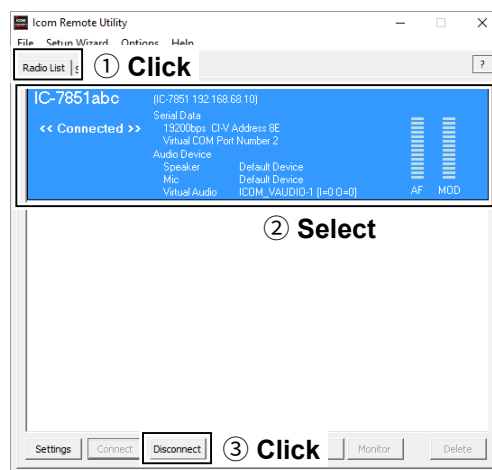

Adjusting audio level using the Remote Utility application

While connected to a Base station transceiver, you can adjust the received and transmit audio volume through the network using the Remote PC's Remote Utility.

The description in this section is based on the assumption that the connection to the transceiver has succeeded. (“<<Connected>>” is displayed under the radio name.)

◇ Adjusting received audio volume

1. Click <Radio List>.
2. Select a transceiver with “<<Connected>>” under its name.
3. Click <AF>.
4. Slide the adjustment bar on the Volume field up or down to adjust the received audio volume level.
 - ① Click <Mute> to mute the audio, and click once again to hear the audio.
5. Click <Close> to close the screen.

◇ Adjusting transmit audio volume

1. Click <Radio List>.
2. Select a transceiver with “<<Connected>>” under its name.
3. Click <MOD>.
4. Select “Mic” in “MOD Select.”
5. Slide the adjustment bar on the Volume field up or down to adjust the transmit audio volume level.
6. Click <Close> to close the screen.

NOTE:

- The AF adjustment bar on the Volume field moves together with the AF control of the Remote Controller. However, if you use another control software, the audio volume level on the network can only be adjusted with the Remote Utility.
- You cannot adjust the received audio volume level of the transceiver's speaker, with the Remote Utility. Use the AF control on the transceiver to adjust it.
- When setting the codec setting for “AF Transmission” to 1 channel, the volume level of both right and left are the same.

NOTE: You cannot adjust the modulation input level of the transceiver with the Remote Utility. Adjust the modulation input level of the transceiver in the transceiver's Set mode, or using the Remote Controller. (p. 6-2)

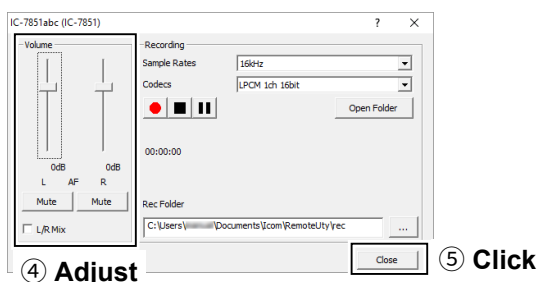
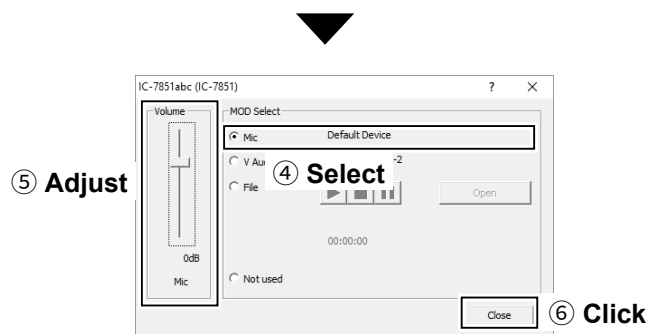
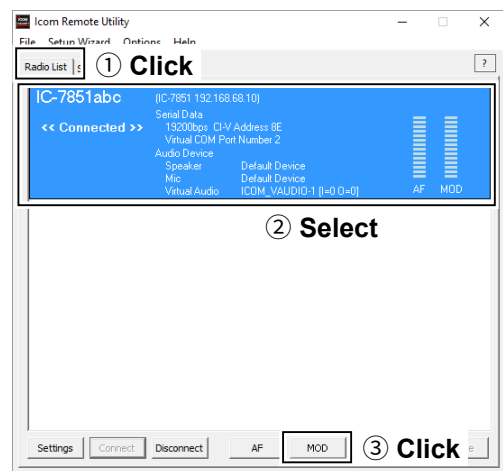
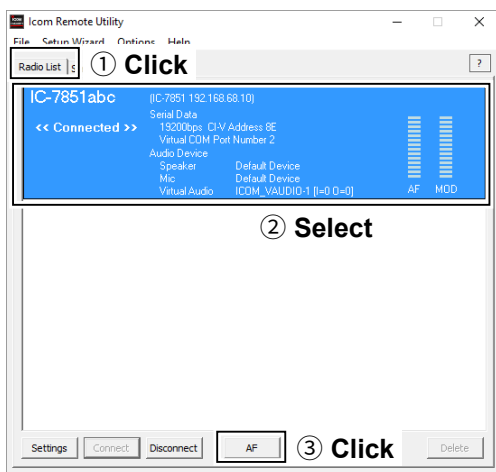

Recording and playback function

While connected to a transceiver, you can record the received audio and save it into the PC's hard disk using the Remote PC's Remote Utility.

Also, you can transmit an audio file to the radio using the Remote Utility.

The description in this section is based on the assumption that the connection to the transceiver has succeeded. ("<<Connected>>" is displayed under the radio name.)

◇ Recording received audio

1. Click <Radio List>.
2. Select a transceiver with "<<Connected>>" under its name.
3. Click <AF>.
4. Click < [Red Dot] > to start recording.
 ⓐ While recording, click < [Pause] > to pause.
5. Click < [Black Square] > to stop recording.

TIP:

- When you click <Open Folder>, the folder in which the recording file is saved is displayed.
- If you want to change the recording folder, click < [Browse] >, then select a folder on the Browse For Folder screen.
- Adjust the sample rate frequency and codec to record the audio according to the recording purpose. When you record the audio received from the network, we recommend that you set the same sample rate frequency and codec that are programmed on the Connection Setting screen.

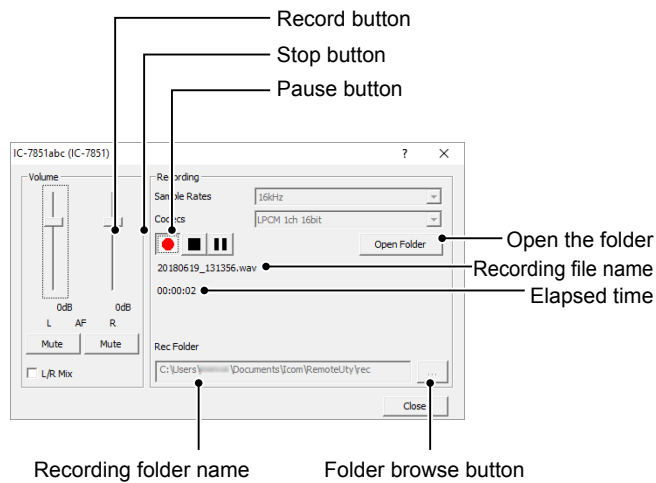
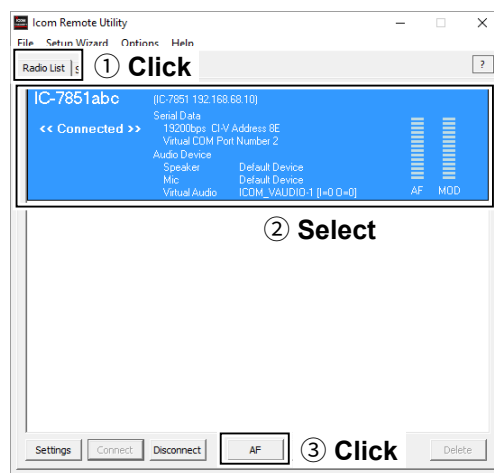

5 ABOUT THE REMOTE UTILITY

Recording and playback function

◇ Playing back and transmitting an audio file

1. Click <Radio List>.
2. Select a transceiver with "<<Connected>>" under its name.
3. Click <MOD>.
4. Select "File" in "MOD Select."
5. Click <Open> to select an audio file* to play or transmit.
* Only uncompressed, linear, PCM WAV files are supported.
6. Click <▶> to start playing/transmitting.
① While playing or transmitting, click <⏸> to pause.
7. Click <■> to stop playing/transmitting.

TIP: You can also use the Remote Controller's Voice Memory function to play back or transmit an audio file. See the Remote Controller's help file for details. To display the help file, click "Contents" in the Help menu on the Remote Controller, or push the [F1] key on your PC's keyboard.

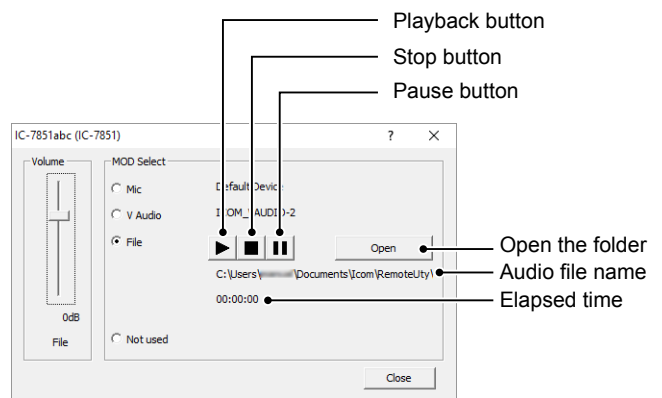
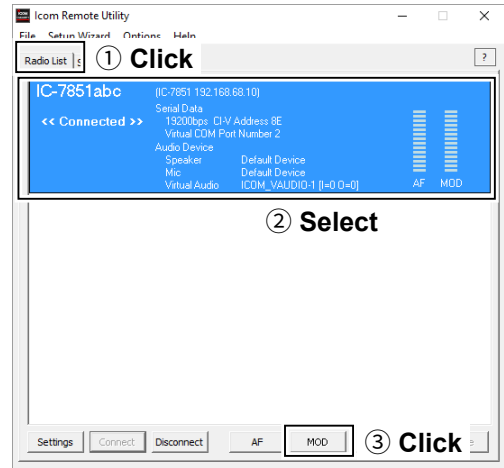

Monitoring another users from the Server PC

When you are operating a Server PC, and another user is accessing a Base station transceiver that is physically connected to your PC, you can monitor the received and transmitted audio.

① To monitor, you should connect a speaker to your PC.

1. In the Server PC's Remote Utility, click the <Radio List> tab.
2. Select a transceiver with "Busy" under its name.
 - ① The operating user's name (PC Name that the Remote PC set in the Network Setting screen), and its IP address are displayed under "Busy."
3. Click <Monitor> to display the Monitor screen.
4. Click <TX Monitor> to turn the Transmit Monitor function ON or OFF.
Click <RX Monitor> to turn the Receive Monitor function ON or OFF.
Slide the adjustment bar on the Volume field up or down to adjust the monitoring audio volume level.
5. Click <Close> to close the screen.

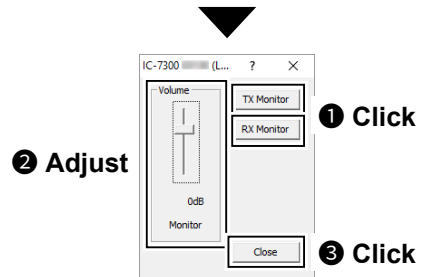
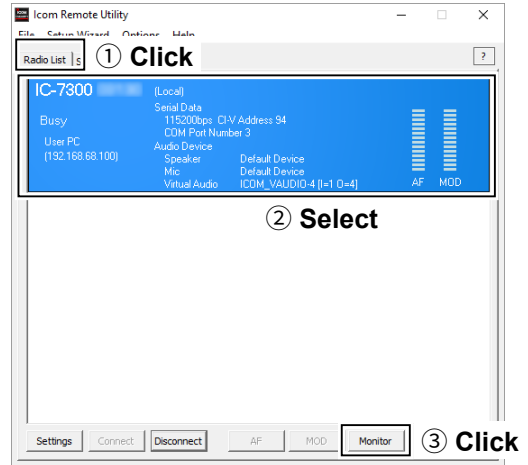

Disconnecting another users

The administrators and the Server PC can terminate a connection between another user and a transceiver.

1. Click <Radio List>.
2. Select a transceiver with “Busy” under its name.
 - ① The operating user’s name (PC Name that the user set in the Settings screen), and its IP address are displayed under “Busy.”
3. Click <Disconnect>.
 - “The radio is in use by a remote PC. Do you want to disconnect?” is displayed.
4. Click <Yes> to terminate the connection.
 - ① When you terminate a connection, no dialog is displayed on the disconnected user’s Remote Utility.

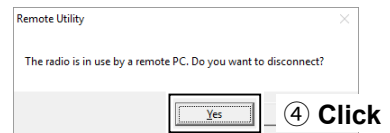
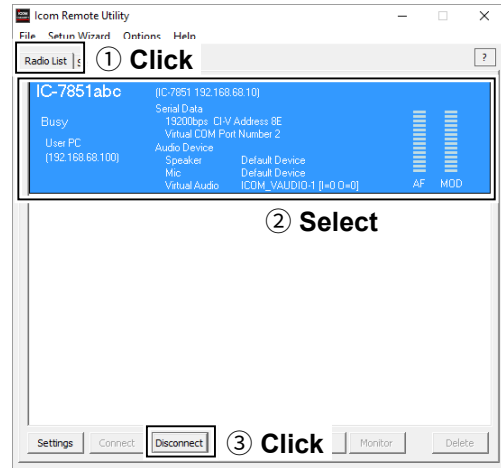

6

ABOUT THE REMOTE CONTROLLER

Connect to the Base station transceiver.
(p. 2-11, p. 3-14, p. 4-15)

About the Remote mode
(p. 6-2)

Open the Connect Setting screen.
(p. 2-11, p. 3-14, p. 4-15)

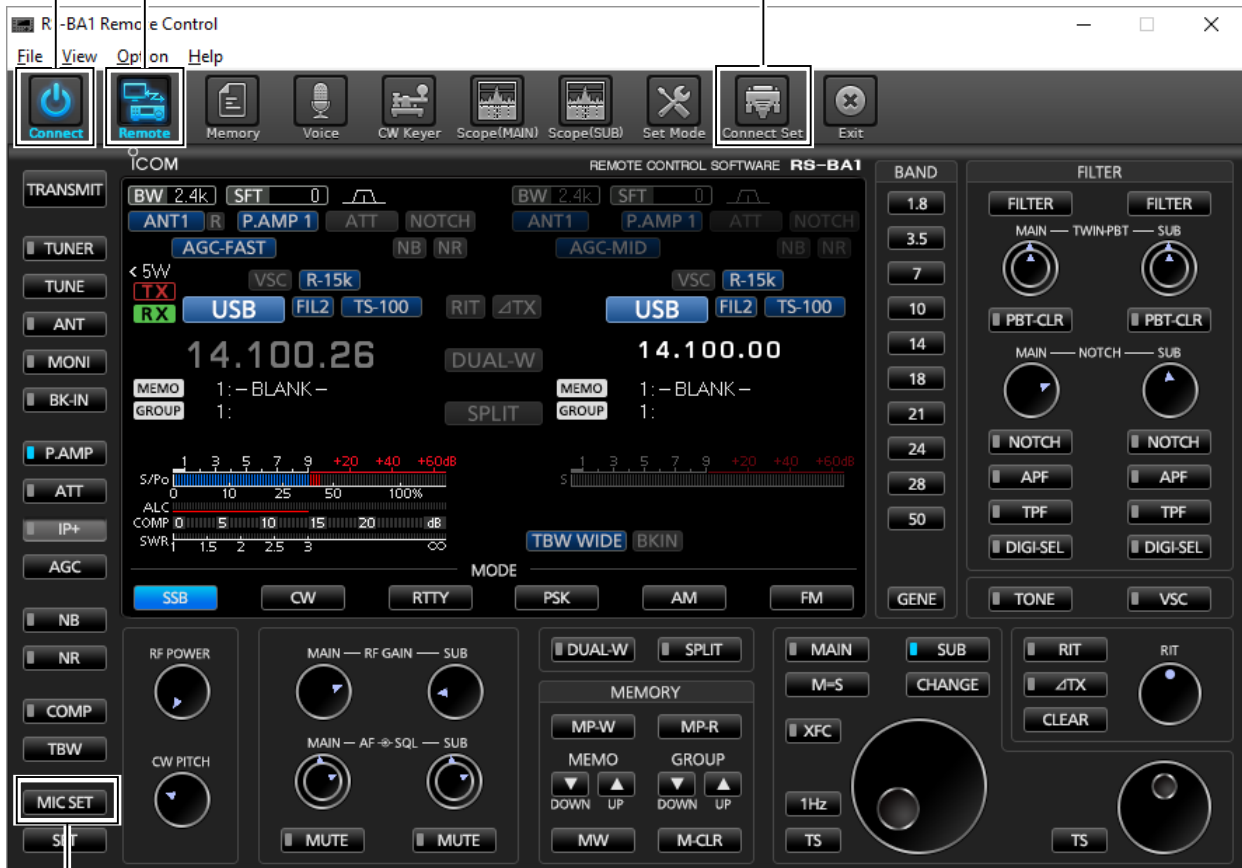

To use transmit audio input from the PC (p. 6-2)

TIP: See the RS-BA1 Remote Controller's Help file for remote operation details, such as how to change the frequency or how to turn ON each function. To display the Help file, click "Contents" in the Help menu on the Remote Controller application, or push the [F1] key on your PC's keyboard. The windows that are displayed by right-clicking on each button on the Remote Controller, see the Operating Guide at the end of this manual.

To use transmit audio input from the PC

In order to use the transmit audio input from the PC function when remotely controlling the transceiver using the Remote Controller, configure the following settings, according to the connection between the transceiver and the Server PC.

If you operate from the Remote PC, confirm the transceiver is connected to the Server PC.

1. Connect to a transceiver with the Remote Controller.
2. Click <MIC SET> to open the MIC SET screen.
3. Select an appropriate connector in **MOD Select (Remote ON)**, to input transmit audio from the PC to the transceiver.
 - ① The options differ, depending on the transceiver selected in **Model** on the Connect Setting screen.
4. Right-click <MOD LEVEL> to rotate clockwise, or left-click it to rotate counterclockwise, to adjust the input level from the connector.
5. Click < X > to close the screen.

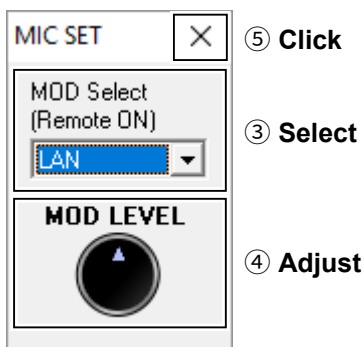

About the Remote mode

When connected to the transceiver, the Remote Controller automatically turns ON the Remote mode. While the Remote mode is ON, the Remote Controller transmits CI-V commands not only to check the transceiver's current state, but also to remotely control it.

When you want the Remote Controller to only check the transceiver's current state, or when you want to inhibit the Remote Controller from transmitting control commands while you manually operate the transceiver, turn OFF the Remote mode.

To turn OFF the Remote mode

Click the Remote icon in the toolbar, or click "Remote OFF" in the File menu.



To turn ON the Remote mode

Click the Remote icon in the toolbar, or click "Remote ON" in the File menu.



- ① You can select the desired connector(s) for transmitting audio input when the Remote mode is OFF. See the Remote Controller's Help file for "Remote Setting" details.

NOTE: DO NOT allow the PC to go into the sleep or standby mode while using the RS-BA1. Otherwise, it might not work properly after the PC resumes normal activity.

Using the RC-28

If you connect the optional RC-28 REMOTE ENCODER to your PC, you can use the RS-BA1 and feel like you are operating the actual transceiver's MAIN dial.

1. Connect the RC-28 to the PC that has RS-BA1 installed.

① When you connect the RC-28 to the PC for the first time, wait until "Device driver software installed successfully." is displayed.

NOTE: DO NOT connect the RC-28 to the PC with other than the supplied USB cable, or through any USB hub. The RC-28 may not work properly.

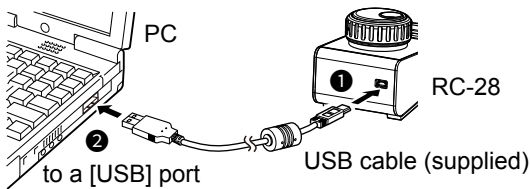

2. Start up the RS-BA1 Remote Control software.

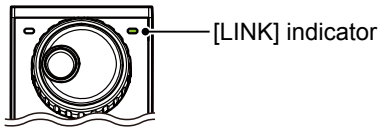

- The [LINK] indicator on the RC-28 lights green.
- Now you can control the assigned functions of the RS-BA1 using the RC-28.

TIP: If the [LINK] indicator does not light, check the following.

1. Click "USB Dial..." in the Option menu to open the USB Dial Setting screen.
2. If **Select Device** is set to "Not Use," set it to the RC-28's serial number.
(Example: RC-28 02XXXXX)

The following are possible causes and solutions for the problem you are experiencing.

If you cannot solve the problem after trying these solutions, please contact your nearest dealer or Icom Service Center.

Problem: Cannot access a Server from a Remote PC with the Remote Utility

① You can configure the Server information on the Server Properties screen. (Server List screen → <Properties>)

“Connection Failed” is displayed under the Server name

IC-7851

Connection
Failed

Possible cause 1

An incorrect IP address, domain name, or network name (Computer name) is entered to request a connection to the Server.

① If the Remote Utility cannot get the Server’s IP address using the domain name or network name (Computer name) that you entered, “Cannot resolve the name” is displayed next to the name.

Solution

1. Check the Server’s IP address, domain name, or network name (Computer name). (pp. 3-2, 4-2)
2. Enter the Server’s correct IP address, domain name, or network name in **Server Address or Network Name** on the Server Properties screen.

Possible cause 2

The control port number is different than that of the Server.

Solution

1. Check the Server’s control port number*. (pp. 2-2, 4-4)
2. Enter the correct port number into **Control Port (UDP)** on the Sever Properties screen.

* The default number is “50001.”

Possible cause 3

The virtual driver is not installed in the Remote PC.

Solution

Install the virtual driver in the Remote PC.
(See the RS-BA1 PREPARATION for details.)

“Logon Failed” is displayed under the Server name

IC-7851

Logon
Failed

Possible cause

The user ID or password is different than the one in the Base station.

Solution

1. Confirm the Remote PC information registered in the Base station. (pp. 3-2, 4-5)
2. Enter the correct user ID and password into **User ID** and **Password** on the Sever Properties screen.

“Disabled” is displayed under the Server name

IC-7851

Disabled

Possible cause

The Server is set to “Disable,” to inhibit connecting to it.

Solution

Enable the Server by removing a check mark from **Disable** on the Sever Properties screen.

NOTE: If you could not solve the problem after trying the solutions, check the following on the Base station.

When connecting to the network directly:

- Is the transceiver turned ON or Remote standby mode?
- Is **Network Control** set to “ON”? (pp. 3-2, 4-5)

When connecting to the network through a PC:

- Is the Remote Utility activated?
- Is your Remote station information registered on the Remote Utility’s User List screen? (p. 5-4)
- Is the Remote Utility added as an exception in the Firewall? (p. 1-1)

Problem: Cannot access a transceiver with the Remote Utility

The description in this part is based on the assumption that the connection to the Server has succeeded.
• “Connected” is displayed under the Server name when the connection is successful.

“Busy” is displayed under the radio name

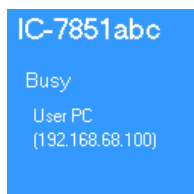

Possible cause
Another user is currently operating the transceiver.

Solution
Wait for “Busy” to disappear.
① If you are operating as an administrator or a Server, you can terminate a connection between another user and a transceiver. (p. 5-16)

“Connect Error” is displayed under the radio name



Possible cause 1
The serial port number (default: 50002) or the audio port number (default: 50003) is not connected.

Solution
Check the Firewall settings for the Remote PC.
When using the Internet, also check the router’s port forwarding settings. (p. 4-4)

Possible cause 2
Access to the selected transceiver is inhibited by the Server PC.

Solution
Allow the Remote PC to access the transceiver with the Server PC’s Remote Utility. (p. 5-4)

“COM/Audio Error” is displayed under the radio name



IC-7851abc

COM/Audio
Error

Possible cause 1

Other applications are using the COM port.

Solution

If other applications are running at the same time, close them.

Possible cause 2

Started the Remote Utility right after the PC has booted.

Solution

Wait for a while after the PC has booted, and then start the Remote Utility.

Possible cause 3

An audio device or COM port has been added to the PC, or removed from the PC. For the USB device, the USB port number has been changed.

Solution

The COM port number or the audio device name may have been changed. Reregister the radio on the Registered Radio List screen. (p. 5-2)

Possible cause 4

The audio or serial wiring is disconnected.

Solution

If you are using a USB serial conversion cable or a USB audio cable, make sure the USB cable is firmly connected.

Make sure the 3.5 (d) mm (1/8") audio cable is firmly connected.

NOTE: If you could not solve the problem after trying the solutions, check the following.

When connecting to the network directly:

- Is the transceiver turned ON or in the Remote standby mode?

When connecting to the network through a PC:

- Is the transceiver turned ON?
- Are the correct COM port number and audio device to which the transceiver is connected selected on the Radio Properties screen?
(Option → Local/Server Settings → Registered Radio List screen → <Properties>)
- Is the Server PC not directly accessing the transceiver using the Remote Controller, without having used the Remote Utility to connect to the transceiver?

Problem: Cannot access a transceiver with the Remote Controller

① To access a transceiver with the Remote Controller, configure the connection settings on the Connect Setting screen. Click <  > in the toolbar, or click “Connect Setting...” in the Option menu to open the screen.

The description in this part is based on the assumption that the connection to the transceiver using the Remote Utility has succeeded.

- “<<Connected>>” is displayed under the radio name when the connection is successful.

When connecting to the transceiver through the network using the Remote Utility

Possible cause 1

In **CI-V** of the Remote Controller’s Connect Setting screen, the CI-V settings are different than that in the Remote Utility.

Solution

On the Connect Setting screen, click <Search>, and then select the correct transceiver in the Remote Utility menu.

- The CI-V settings are automatically loaded from the Remote Utility.

Possible cause 2

Other applications are using the COM port.

Solution

If other applications are running at the same time, close them.

NOTE: If you could not solve the problem after trying the solutions, check the following.

When connecting to the network directly:

- Is the transceiver turned ON or in the Remote standby mode?

When connecting to the network through a PC:

- Are the same CI-V address and baud rate that are programmed into the transceiver set on the Radio Properties screen?
(Option → Local/Server Settings → Registered Radio List screen → <Properties>)

When directly accessing the transceiver without using the Remote Utility

Possible cause 1

An incorrect COM port number is set on the Remote Controller’s Connect Setting screen.

Solution

1. Check the COM port to which the transceiver is connected, on your PC’s Device Manager.
2. Set the correct COM port number to **COM Port** on the Remote Controller’s Connect Setting screen.

Possible cause 2

The CI-V address or baud rate is different than that are set into the transceiver.

Solution

1. Check the transceiver’s CI-V address and baud rate.
 - ① See the transceiver’s instruction manual for details.
2. Enter the transceiver’s correct CI-V address in **CI-V address (Radio)**, and select the transceiver’s correct baud rate in **Baud rate (bps)**, on the Remote Controller’s Connect Setting screen.
 - ① If the radio’s baud rate is set to “Auto,” select “19200” in the Baud rate (bps) menu.
 - ① If you are using the Spectrum Scope function with the IC-7851, IC-7850, IC-7610, or IC-7300 using a USB for the connection, select “115200” in the Baud Rate menu.

Possible cause 3

Other applications are using the COM port.

Solution

If other applications are running at the same time, close them.

Problem: The DUAL mode screen of the Remote Controller cannot be displayed

① To access a transceiver with the Remote Controller, configure the connection settings on the Connect Setting screen. Click <  > in the toolbar, or click “Connect Setting...” in the Option menu to open the screen.

Possible cause

An incorrect transceiver's model is set on the Remote Controller's Connect Setting screen.

Solution

Select a model named with “(DUAL).”

Problem: Cannot properly control the transceiver with the Remote Controller

Possible cause

The same CI-V address is being used by other control software.

Solution

Select an address other than “E0” in **CI-V Address (RS-BA1)** on the Remote Controller's Connect Setting screen. However, this solution does not always solve the problem.

NOTE:

If you could not solve the problem after trying the solutions, check the following.

- Are there any radios that have the same CI-V address in the system?

Problem: The received audio cannot be heard.

The description in this part is based on the assumption that the connection to the transceiver has succeeded.

- “<<Connected>>” is displayed under the radio name when the connection is successful.

Possible cause 1

The speaker is not turned ON, or the volume level is too low.

Solution

Turn ON the speaker, or adjust the volume level.

Possible cause 2

An earphone or other device is connected to the computer in place of the speaker.

Solution

Disconnect the device.

Possible cause 3

The appropriate audio device is not selected in the Remote Utility.

Solution

Select the appropriate audio device in **Speaker** on the Connection Setting screen.

(Radio List screen → <Settings>) (pp. 3-12, 4-13)

- ① If you connect a new USB audio device to your PC, the audio device which is selected as a default device in your PC can be changed. If you select “Default Device” in **Speaker**, keep that in mind.

Possible cause 4

The volume level of the audio device is set to too low on your PC.

Solution

Adjust the volume level of the audio device. (p. 1-5)

- ① The PC has the Volume Mixer function that can adjust each application’s audio level. Confirm that the Remote Utility or the control software is not muted, or set it to an appropriate volume level.

Possible cause 5

Audio output is disabled in the Remote Utility.

Solution

Insert a check mark in **AF Transmission** on the Connection Setting screen.

(Radio List screen → <Settings>)

Possible cause 6

The volume level is too low, or the mute is turned ON in the Remote Utility.

Solution

Adjust the volume level on the Received Audio Adjustment screen.

(Radio List screen → <AF>) (p. 5-12)

NOTE:

If you could not solve the problem after trying the solutions, check the following.

When connecting to the network directly:

- Is **Network AF** set to an appropriate level in the Others set mode?

When connecting to the network through a PC:

- Is the volume level of the audio device that the transceiver is connected to set to an appropriate level?

Problem: The received audio cannot be heard in the DUAL mode.

① See also “Problem: The received audio cannot be heard.”

Possible cause 1

The codec setting for the received audio is set to 1 channel on the Remote Utility's Settings screen.

Solution

Set the codec setting for the received audio to 2 channels.

Possible cause 2

When the transceiver is connected to the PC with a USB cable, the audio device setting is incorrect.

Solution

Set the microphone's Default Format to 2 channels on the Windows Sound setting screen.

Problem: The transmit audio cannot be output.

The description in this part is based on the assumption that the connection to the transceiver has succeeded.

• “<<Connected>>” is displayed under the radio name when the connection is successful.

① To check the Remote PC's transmit IF signals, use the Transmit Monitor function with the Server PC's Remote Utility, or place a receiver near the Remote PC or Server PC.

Possible cause 1

The microphone is not turned ON, or the input level is too low.

Solution

Turn ON the microphone, or adjust the input level.

Possible cause 2

The appropriate audio device is not selected in the Remote Utility.

Solution

Select the appropriate audio device in **Mic** on the Connection Setting screen.

(Radio List screen → <Settings>) (p. 5-10)

① If you connect a new USB audio device to your PC, the audio device which is selected as a default device in your PC can be changed. If you select “Default Device” in **Mic**, keep that in mind.

Possible cause 3

The input level of the audio device is set to too low on your PC.

Solution

Adjust the input level of the audio device. (p. 1-5)

Possible cause 4

Audio input is disabled in the Remote Utility.

Solution

Insert a check mark in **MOD Transmission** on the Connection Setting screen.

(Radio List screen → <Settings>)

Possible cause 5

The input level is too low in the Remote Utility.

Solution

Adjust the input level on the Transmit Audio Adjustment screen.

(Radio List screen → <MOD>) (p. 5-12)

Possible cause 6

An incorrect connector is selected in the Remote Controller.

Solution

Select the proper transceiver's connector which is connected to the Server PC, in **MOD Select (Remote ON)** on the Remote Controller's MIC SET screen. (p. 6-2)

NOTE:

If you could not solve the problem after trying the solutions, check the following.

When connecting to the network directly:

• Is **Network AF** set to an appropriate level in the Others set mode?

When connecting to the network through a PC:

• Is the volume level of the audio device that the transceiver is connected to set to an appropriate level?

Problem: The received audio is intermittent

Possible cause 1

The network data transfer is excessive.

Solution

Select a lower sampling rate value in **Sample Rates**, or a different codec in **Codecs**, on the Connect Settings screen. (Radio List screen → <Settings>)

- ① First, select the lowest value. If the received audio is not interrupted with the setting, try a higher value, and adjust to an appropriate value.

Possible cause 2

The capacity of the prebuffer is not enough.

Solution

Select a longer value in **Prebuffer (ms)** on the Connection Setting screen.

(Radio List screen → <Settings>)

- ① Select as short a value as possible, because longer prebuffers can cause a delay, and make it difficult to adjust the audio level.

Possible cause 3

Your PC is overloaded.

Solution 1

Shutdown other applications, if running.

Solution 2

Reduce the number of transceivers you are accessing with the Remote Utility.

NOTE:

- If you are accessing the transceiver through a network, removing a check mark from **Retransmission** on the Connection Setting screen can solve the problem. (Radio List screen → <Settings>)
- You can check the simplified packet round trip time, and the average packet loss on the Remote Utility's Server List screen.

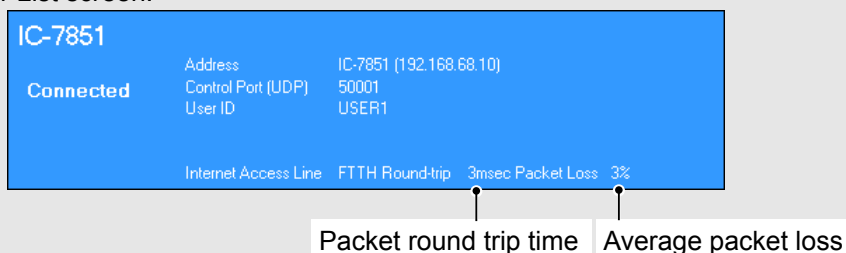

Problem: The connect settings cannot be changed

IC-7851abc

Offline

Possible cause 1

The transceiver is "Offline."

Solution

Click <Connect> on the Server List screen to connect to the server.

IC-7851abc

<< Connected >>

Possible cause 2

"<<Connected>>" is displayed.

Solution

Click <Disconnect> on the Radio List screen to disconnect from the transceiver.

Problem: The connect settings cannot be changed using the Remote Controller

Possible cause

The Remote Controller is connected to the transceiver.

Solution

Click <  > to disconnect it from the transceiver.

Count on us!



Remote Controller Operating Guide (DUAL mode screen)

The following windows are displayed by right-clicking on each button on the Remote Controller.

- ① There are some windows that are displayed by left-clicking. The buttons are marked in white. (Example: Memory Channel Editor).
- ② The windows whose title are with "(MAIN)" are displayed when you select the MAIN band. When you select the SUB band, "(SUB)" is displayed instead.
- ③ The windows that are displayed by right-clicking can also be displayed by right-clicking on the screen icons.

TIP:

- You can select either "Knob" or "Slider" on the Set Mode screen to adjust each setting. (Set Mode > Controllers > **Control Type**)
- Some windows are not displayed, depending on the connected transceiver.

The diagram illustrates the RS-BA1 Remote Control software interface, showing the main control screen and various windows accessible through right-clicking on buttons. The main screen displays a frequency of 14.100.26 MHz and is in USB mode. The interface includes various controls for transmission, reception, and settings.

The windows shown are:

- Memory Channel Editor**: A table with columns for CH, Name, Split, Operating Freq, and DUP. It shows two channels.
- Voice Memory**: A window with buttons T1 through T8 and a LEVEL knob.
- CW Keyer**: A window with a Log field, Input field, and buttons M1 through M8.
- Spectrum Scope (MAIN)**: A window showing a spectrum plot with a peak at 0 dB. It includes a REF Level of +20.0 dB and a VBW of NAR.
- Set Mode**: A window with various settings, including ACC AF Output Level (128 [50%]), ACC AF SQL (OFF [Open]), S/PDIF Output Level (128 [50%]), and Control Type (Knob).
- AGC (MAIN)**: A window with AGC OFF, AGC-FAST Delay (SSB) (0.3), and AGCVR SPEED.
- NB (MAIN)**: A window with LEVEL, DEPTH, and WIDTH knobs.
- NR (MAIN)**: A window with a LEVEL knob.
- MIC SET**: A window with MOD Select (Remote ON) (LAN) and MOD LEVEL knob.
- COMP**: A window with a LEVEL knob.
- PSK**: A window with Tone Frequency (1500Hz).
- SPLIT**: A window with Offset (kHz) (0).
- RTTY**: A window with Mark Frequency (2125Hz) and Shift Width (170Hz).
- SET**: A window with RX (MAIN) (SSB) settings (Bass, Treble, HPF, LPF) and TX (SSB) settings (Bass, Treble, SSB TBW (WIDE), TX Power Limit).
- Filter (MAIN)**: A window with SSB, FIL3, Roofing, Type (SHARP), and Adjust knob.
- Adjust (MAIN)**: A window with a CAL knob.
- APF (MAIN)**: A window with Width (WIDE), Type (SOFT), and AF Level (0dB).
- DIGI-SEL (MAIN)**: A window with a SHIFT knob.
- TONE (MAIN)**: A window with Frequency (88.5Hz) and an "Add to the Operating Frequency" button.

The main screen also shows various controls for TRANSMIT, TUNE, BAND, FILTER, and MODE. The interface is designed for remote control of a transceiver, providing a comprehensive set of settings and monitoring tools.

- ① The example when connecting the IC-7850 or IC-7851. The window differs, depending on the transceiver's Scope function.
- ② The example when connecting the IC-7850 or IC-7851. The window differs, depending on the transceiver.
- ③ Displayed when using the Tone function. The window differs, depending on the Tone function you use.
- ④ Click to display the Scope screen of the SUB band.
- ⑤ Displayed when using the RIT function or Δ TX function.

Remote Controller Operating Guide (Single mode screen)

The following windows are displayed by right-clicking on each button on the Remote Controller.

① There are some windows that are displayed by left-clicking. The buttons are marked in white.
(Example: Memory Channel Editor).

② The windows that are displayed by right-clicking can also be displayed by right-clicking on the screen icons.

TIP:

- You can select either “Knob” or “Slider” on the Set Mode screen to adjust each settings.
(Set Mode > Controllers > **Control Type**)
- Some windows are not displayed, depending on the connected transceiver.

Memory Channel Editor

CH	Name	Split	Operating Freq	DUP
1				
2				

Voice Memory

T1	T2	T3	T4
T5	T6	T7	T8

Remote Setting

MOD Select (Remote ON->OFF)

 Dial Lock while Remote ON

AGC

AGC OFF
 AGC-FAST Delay (SSB)

 AGCVR SPEED

NB

LEVEL DEPTH WIDTH

NR

LEVEL

MIC SET

MOD Select (Remote ON)

 MOD LEVEL

SET

RX (SSB) TX (SSB) DRIVE GAIN
 Bass 0 Treble 0
 HPF OFF LPF OFF
 SSB TBW (WIDE) Low 100Hz High 2900Hz
 TX Power Limit (14M) 200 [W] (AM Power: 50W)

CW

Rise Time Normal Side
 LSB
 DOT/DASH RATIO KEY SPEED SIDE TONE LEVEL
 1:1:2.8

RTTY

Mark Frequency

 Shift Width

PSK

Tone Frequency

100

1k
5k
6.25k
9k
10k
12.5k
20k
25k
50k
100k
1M

SPLIT

Offset (kHz)

Adjust

Adjust knob

NOTCH1

Manual Notch 1 Q

NOTCH2

Manual Notch 2 Q

APF

SHIFT Width Type AF Level
 SOFT 0dB

DUP

DUP Offset Frequency (MHz)

DIGI-SEL

SHIFT

Select Call Sign
 TX Message
 Call Sign Memory
 Digital Setting
 Received call record

Spectrum Scope

SPECTRUM SCOPE CENTER MAIN Grid 5k/10dB
 -25k +25k
 REF Level: +20.0 dB VBW: NAR Averaging: OFF MAX HOLD CLEAR SET

Set Mode

Set Mode

ACC AF Output Level	128 (50%)
ACC AF SQL	OFF (Open)
ACC-B AF Output Level	128 (50%)
ACC-B AF SQL	OFF (Open)
S/PDIF Output Level	128 (50%)
S/PDIF SQL	OFF (Open)
USB Audio Output Level	128 (50%)
USB Audio SQL	OFF (Open)
LAN AF SQL	ON

ANT
 ANT Select Enable OFF

Meter
 Meter Peak Hold ON

Memopad
 Memopad Numbers 5

NOTCH
 [NOTCH] Switch (SSB) Auto/Manual
 [NOTCH] Switch (AM) Auto/Manual

Beep
 Confirmation Beep ON

Controllers
 Control Type Knob

- ① The example when connecting the IC-7850 or IC-7851. The window differs, depending on the transceiver's Scope function.
- ② The example when connecting the IC-7850 or IC-7851. The window differs, depending on the transceiver.
- ③ Displayed when using the Tone function. The window differs, depending on the Tone function you use.
- ④ Displayed during the Duplex operation.
- ⑤ Displayed when using the RIT function or Δ TX function.